

# Reference Codes

## Controls

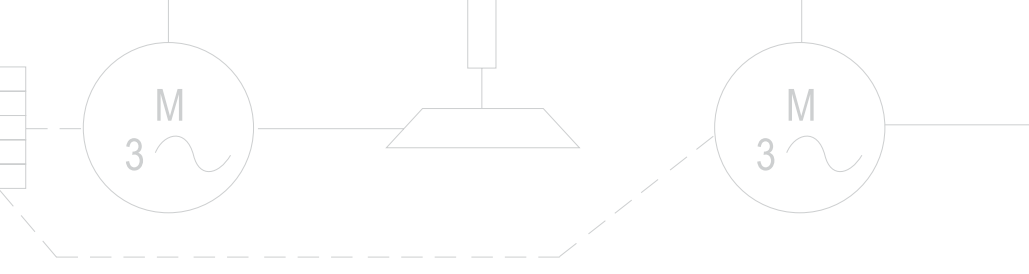
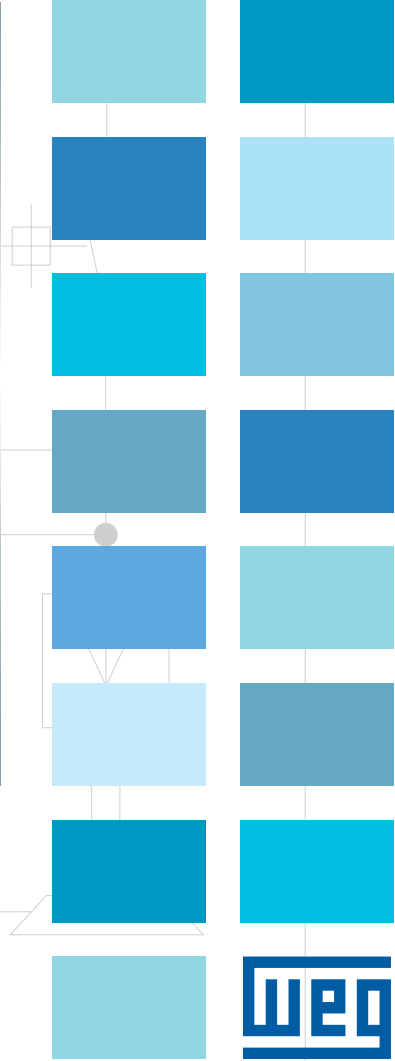
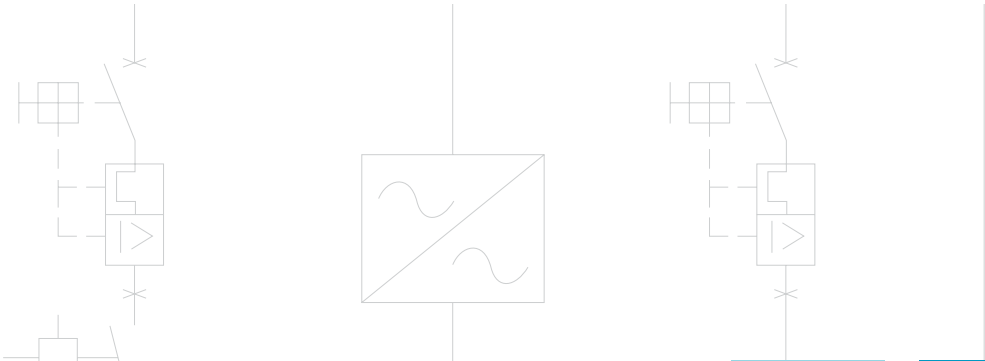

# Power Contactors

Model
CWMC
CWCO
CWCIO
CWCHO
CWM
CWB

Main contacts	Code
2NO	20
3NO	30
4NO	40
2NC	02
2NO+2NC	22

Terminal type	Code
Screw	Blank
For printed circuit board	I
Spring	S

C	W	M			1	2		-	1	0		-	3	0		-	V	4	0	
---	---	---	--	--	---	---	--	---	---	---	--	---	---	---	--	---	---	---	---	--

Rated current In (AC-3)	Code
7 A	7
9 A	9
12 A	12
16 A	16
18 A	18
25 A	25
32 A	32
38 A	38
40 A	40
50 A	50
65 A	65
80 A	80
95 A	95
105 A	105
112 A	112
150 A	150
180 A	180
250 A	250
300 A	300
400 A	400
500 A	500
630 A	630
800 A	800

Auxiliary contacts	Code
1NO	10
1NC	01
1NO+1NC	11
1NO+3NC	13
2NO+2NC	22
3NO+1NC	31
4NO	40
4NC	04
4NO+4NC	44
None	00

Coil voltage	Code
24 V 50/60 Hz	D02
220 V 50/60 Hz	D23
24 V dc	C03
220 V dc	C15

Complete table at pages 21 and 22



# Control Relays

Model
CWCA0

Coil voltage	Code
24 V 50/60 Hz	D02
220 V 50/60 Hz	D23
24 V dc	C03
220 V dc	C15
Complete table at pages 21 and 22	

**C W C A 0 - 2 2 - 0 0 - V 4 0**

Auxiliary contacts <sup>1)</sup>	Code
1NO+1NC	11
1NO+3NC	13
2NO+2NC	22
3NO+1NC	31
4NO	40
4NC	04
4NO+4NC	44
5NO+3NC	53
6NO+2NC	62
7NO+1NC	71
8NO	80
8NC	08

Terminal type	Code
Screw	Blank
For printed circuit board	I
Spring	S



Note: 1) Configurations with more than 4 auxiliary contacts can be achieved only by adding auxiliary contact blocks.



# Overload Relays

## Bimetallic Relays

Model
RW17
RW27
RW67
RW117
RW317
RW407

Connector links
1 D
2 D

Poles
2
3



**R W 1 1 7 - 2 D 3 - U 0 8 0**

Rated current (A)	Code
0.28-0.4	D004
0.4-0.63	C063
0.56-0.8	D008
0.8-1.2	D012
1.2-1.8	D018
1.8-2.8	D028
2.8-4	U004
4-6.3	D063
5.6-8	U008
7-10	U010
8-12.5	D125
10-15	U015
11-17	U017
15-23	U023
22-32	U032

Rated current (A)	Code
32-40	U040
25-40	U040
32-50	U050
40-57	U057
50-63	U063
57-70	U070
63-80	U080
75-97	U097
90-112	U112
100-150	U150
140-215	U215
200-310	U310
275-420	U420
400-600	U600
560-840	U840

## Solid-State Relays

Model
RWB40
RWM40
RWM112
RWM420
RWM840

Rated current (A)	Code
0.4-2	U002
1.6-8	U008
5-25	U025
8-40	U040
14-56	U056
28-112	U112
50-250	U250
85-420	U420
170-840	U840



**R W B 4 0 - 3 - A 4 U 0 4 0**

## Smart Relay - Control Unit

Communication protocol	Code
No communication	B
DeviceNet	D
Modbus-RTU	M
Profibus-DP	P

Protection	Code
PTC	T
Earth leakage	E

**S R W 0 1 - U C P T 1 E 4 7**

Digital input operating voltage	Code
24 V dc	1
110 V ac	2

Supply voltage	Code
24 V ac (50-60 Hz) / V dc	E26
110-240 V ac (50-60 Hz) / V dc	E47



## Motor Protective Circuit Breaker

Model
MPW12
MPW18
MPW40
MPW80
MPW100

Type of protection	Code
Thermomagnetic ( $I_m \times I_3$ )	Blank
Magnetic only ( $I_m \times I_3$ )	i
Thermomagnetic ( $I_m \times I_{19}$ )	t

Terminal type	Code
Screw	Blank
Spring <sup>1)</sup>	S

**M P W 4 0 i - 3 - D 0 6 3**

Rated current (A)	Current (A)	Code
0.1-0.16	0.16	C016
0.16-0.25	0.25	C025
0.25-0.4	0.4	D004
0.4-0.63	0.63	C063
0.63-1	1	U001
1-1.6	1.6	D016
1.6-2.5	2.5	D025
2.5-4	4	U004
4-6.3	6.3	D063
6.3-10	10	U010
8-12	12	U012
10-16	16	U016
16-20	20	U020
20-25	25	U025
25-32	32	U032
32-40	40	U040
40-50	50	U050
50-65	65	U065
55-75	75	U075
65-80	80	U080
70-90	90	U090
80-100	100	U100



Note: 1) Spring terminal available only for MPW12 (up to 12 A).

# Pushbuttons - CSW Pushbuttons and Pilot Lights

Line	Code
Standard	CSW
New line	CSW2

Type	Code
Pushbutton	B

Color	Code
White/translucid	0
Red	1
Green	2
Yellow	3
Blue	4
Black	5
Orange	6
N/A (CSW-BES)	Blank

Flange	Code
No flange	WH
Flange AF3 (old version)	Blank



Front type	Available for line	Code
Mushroom	CSW	C
Illuminated mushroom		CI
Illuminated extended		SI
Double (CSW)		D
Emergency with key		EY
Emergency (CSW)		EG
Illuminated flush		FI
Extended		S
Flush (CSW)		F
Guarded		GA
Emergency stop - pull to release		ESP
Emergency stop - turn to release		ESG
Emergency stop - key to release		ESY
Emergency stop with green position indicator - pull to release		ESPS
Emergency stop with green position indicator - turn to release		ESGS
Emergency stop with green position indicator - key to release		ESYS
Mushroom with latch - turn to release	CSW2	CT
Mushroom with latch - key to release		CY
Flush double		DF
Extended double		DS
Illuminated flush double <sup>1)</sup>		DFI
Illuminated extended double <sup>1)</sup>		DSI
Flush triple <sup>1)</sup>		TF
Extended triple	TS	



## Selector Switches - CSW Pushbuttons and Pilot Lights

Line	Code
Default	CSW

Type	Code
Selector switch	C

Release	Code
Return	R
Return right	RD
Return left	RE
Fixed	F

Angle	Code
45°	45
90°	90

Flange	Code
No flange	WH
Flange AF3 (old version)	Blank

C	S	W	-	C	K	3	F	4	5	W	H
---	---	---	---	---	---	---	---	---	---	---	---

Front type	Code
Lever	A
With key	Y
Illuminated knob	KI
Knob	K

Positions
3
2

Voltage	Code
White/translucid	0
Red	1
Green	2
Yellow	3
Blue	4
Black (default CSW-CK)	Blank
N/A (Key)	Blank



## Pilot Lights - CSW Pushbuttons and Pilot Lights

Line	Code
Default	CSW

Color	Code
White/translucid	0
Red	1
Green	2
Yellow	3
Blue	4
Black	5
Orange	6

Flange	Code
New flange	F
Old version	Blank

Flange	Code
New flange	3VF
Old version	Blank

C	S	W	-	S	D	1	F	3	F	V
---	---	---	---	---	---	---	---	---	---	---

Frontal	Code
CSW	SD

Line	Voltage	Code
CSW	12 V ac/dc	E25
	24 V ac/dc	E26
	48 V ac/dc	E27
	110-130 V 50/60 Hz	D61
	220-240 V 50/60 Hz	D66
	125 V dc	C13



## Common Sets - CSW Pushbuttons and Pilot Lights

Line	Code
Default	CSW
New line	CSW2

Tip	Code
Pushbutton	B
Selector switch	C
Signalling light	S

Positions	Code
3	3
2	2
N/A	Blank

Position	Code
Return	R
Return right	RD
Return left	RE
Fixed	F
N/A	Blank

**C**
**S**
**W**
**-**
**B**
**F**
**I**

Available for type	Front type	Available for line	Code	
Signalling light	Diffused	CSW	D	
	Selector switch		Lever	A
			With key	Y
Illuminated knob			KI	
Knob			K	
Pushbutton	Mushroom		C	
	Illuminated mushroom		CI	
	Illuminated extended		SI	
	Double		D	
	Emergency stop key to release		ESY	
	Emergency stop turn to reset (CSW)		ESG	
	Emergency stop pull to release (CSW)		ESP	
	Emergency stop with green position indicator - pull to release		ESPS	
	Emergency stop with green position indicator - turn to release		ESGS	
	Emergency stop with green position indicator - key to release		ESYS	
	Illuminated flush		FI	
	Extended		S	
	Flush		F	
	Guarded		GA	
	Flush double		DF	
	Extended double		DS	
Illuminated flush double <sup>1)</sup>	DFI			
Illuminated extended double <sup>1)</sup>	DSI			
Flush triple <sup>1)</sup>	TF			
Extended triple	TS			

Angle	Code
45°	45
90°	90

*Only for selector switches*





Color	Code
White/translucid	0
Red	1
Green	2
Yellow	3
Blue	4
Black	5
Orange	6

Qty of blocks 2NO (BC20)
1
2
3
4
5
0

Qty of blocks 1NC (BCM01)
1
2
3
0

Flange	Code
New flange	F
Old version	Blank

Voltage	Code
12 V dc 50/60 Hz	E25
24 V dc 50/60 Hz	E26
48 V dc 50/60 Hz	E27
110-130 V dc 50/60 Hz	D61
110-130 V dc	C40
110 V 50/60 Hz	D13
125 V dc	C13
220 V 50/60 Hz	D23
220-240 V 50/60 Hz	D66

Flange	Code
New flange	3VF
Old version	Blank

2 - 0 0 2 0 0 0 0 0 F D 6 6 3 F V

Qty of blocks 1NO (BC10)
1
2
3
4
5
0

Qty of blocks 1NO+1NC (BC11)
1
2
3
4
5
0

Qty of blocks 1NO early make (BCA10)
1
2
3
4
5
0

Qty of blocks 1NC (BC01)
1
2
3
4
5
0

Qty of blocks 2NC (BC02)
1
2
3
4
5
0

Qty of blocks 1NC late break (BCR01)
1
2
3
4
5
0



## Enclosed Direct On Line Starter

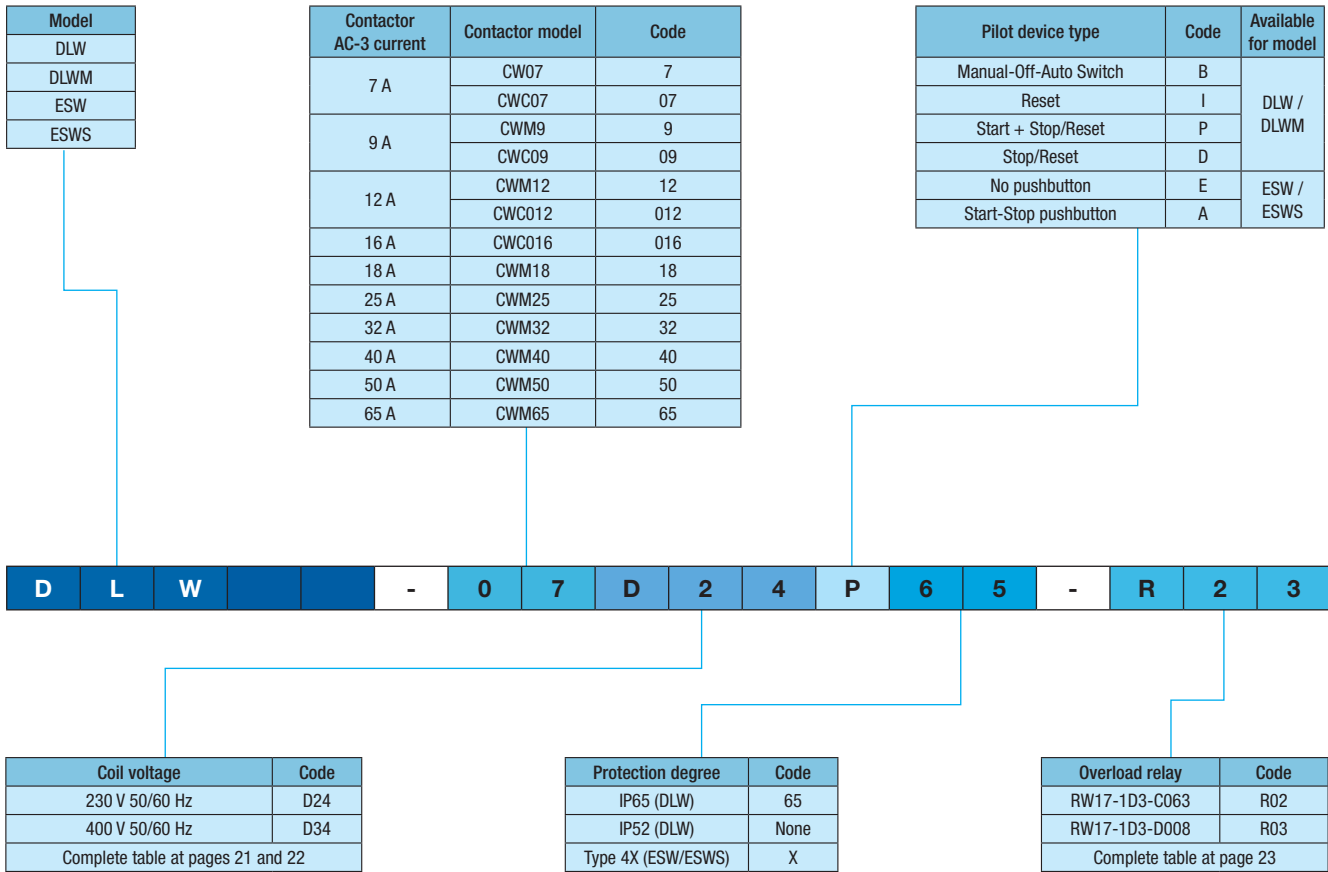

# Electronic Timing Relays



Type	Code
Single function	RTW
Multifunction	ERWT

Auxiliary contacts	
Type	Code
1 NOC <sup>4)</sup>	01
2 NOC	02

Timing selection	
Time range	Code
0.1 - 1s <sup>5)</sup>	U001S
0.3 - 3s	U003S
1 - 10s	U010S
3 - 30s	U030S
6 - 60s	U060S
10 - 100s	U100S
30 - 300s	U300S
1 - 10min <sup>6)</sup>	U010M
3 - 30min <sup>6)</sup>	U030M
0.1s - 10min <sup>7)</sup>	MAT
0.2s - 150h <sup>7)</sup>	MBT
0.1s - 10 days <sup>8)</sup>	MT1

**E R W T - M F 1 - 0 2 - M T 1 - E 0 5**

Function	Code
ON delay	RE
Pulse ON	PE
Pulse flasher - start ON <sup>1)</sup>	CI
Pulse flasher - start OFF <sup>1)</sup>	CIR
Symmetric flasher - start ON	CIL
Symmetric flasher - start OFF	CID
OFF-delay	RD
OFF-delay no control <sup>1)</sup>	RDI
Star-delta <sup>2)</sup>	ET
<b>8 selectable functions<sup>3)</sup></b>	<b>MF1</b>
ON-delay (A)	
OFF-delay with control signal (Ba)	
ON- and OFF-delay with control signal (Ca)	
Symmetrical flasher, starts with pulse on (Da)	
Symmetrical flasher, starts with pulse off (Db)	
Interval (E)	
Retriggerable interval with control signal off (Fa)	
Star-Delta (G)	
<b>8 selectable functions<sup>3)</sup></b>	<b>MF2</b>
ON and OFF delay with control signal (Cb)	
Asymmetrical flasher, starts with pulse OFF (Dd)	
Percentage flasher, starts with pulse OFF (Df)	
Delayed adjustable-length pulse (Ia)	
Asymmetrical flasher, starts with pulse ON (Dc)	
Percentage flasher, starts with pulse ON (De)	
Flasher to reversing motor (Dg)	
Bistable (J)	

Supply voltage		
Alternating current (50/60 Hz) / Direct current		
Description	Applicable to the following RTW models	Code
24 V ac / 24 V dc	RE, PE, CI, CIR, CIL, CID, ET	E26
48 V ac / 24 V dc	RE, PE, CI, CIR, CIL, CID, ET	E33
110-130 V ac / 24 V dc	RE, PE, CI, CIR, CIL, CID, ET	E37
220-240 V ac / 24 V dc	RE, PE, CI, CIR, CIL, CID, ET	E40
24-240 V ac / 24-240 V dc	RE, PE, CI, CIR, CIL, CID, ET, RD, RDI	E05 <sup>9)</sup>
Alternating current (50/60 Hz)		
Description	Applicable to the following RTW models <sup>10)</sup>	Code
24 V ac	RD	D02
48 V ac	RD	D07
110-130 V ac	RD	D61
220-240 V ac	RD	D66
380-440 V ac	RE, PE, ET	D71
Direct current		
Description	Applicable to the following RTW models	Code
24 V dc	RD	C03

**Notas:**

- 1) Not available for multi-timing models (RTW-M);
- 2) RTW-ET is available only with two timing options: 3 - 30s (code U030S) and 0.1s - 10min (code MAT);
- 3) MF1 and MF2 functions available only on multifunction models ERWT;
- 4) Not available for star-delta models (RTW-ET) and multifunction models (ERWT-MF1, MF2);
- 5) Timing range 0.1 - 1s (code U001S) is not available for Models RTW-CI, CIR, RD and RDI;
- 6) Timing ranges 60 - 600s (code U010M) and 3 - 30min (code U030M) are available only for model RTW-RDI;
- 7) Timing ranges 0.1s - 10min (code MAT) and 0.2s - 150h (code MBT) are available only for models RTW-RE, PE, RD, CIL, CID and ET;
- 8) Timing range 0.1s - 10 days (code MT1) is available only for multi function models ERWT-MF1 and MF2;
- 9) E05 supply voltage available for:  
 Single timing models: RTW-CI, CIR e RDI  
 Multi timing models (MAT / MBT): RE, PE, CI, CIL, CIR, CID, RD e ET  
 Multi function models: MF1 and MF2;
- 10) Available only for single-timing models.

## Electronic Monitoring Relays

### Phase Loss Protector



**R P W - F F - D 7 0**

Phase loss

Supply voltage	Code
220-240 V 50/60 Hz	D66
380-415 V 50/60 Hz	D70
440-480 V 50/60 Hz	D74

### Phase Sequence Protector



**R P W - S F - D 7 0**

Phase sequence

Supply voltage	Code
220-240 V 50/60 Hz	D66
380-415 V 50/60 Hz	D70
440-480 V 50/60 Hz	D74

### Phase Loss and Phase Sequence Protector



**R P W - F S F - D 7 0**

Phase loss and phase sequence

Supply voltage	Code
220-240 V 50/60 Hz	D66
380-415 V 50/60 Hz	D70
440-480 V 50/60 Hz	D74

### Undervoltage and Overvoltage Protector



**R P W - S S M D 2 3**

Undervoltage and overvoltage

Power supply system	
Blank	Three phase
M	Single phase

Supply voltage	Code
208 V 50/60 Hz	D77
220 V 50/60 Hz	D23
230 V 50/60 Hz	D24
240 V 50/60 Hz	D25
380 V 50/60 Hz	D33

Supply voltage	Code
400 V 50/60 Hz	D34
415 V 50/60 Hz	D35
440 V 50/60 Hz	D36
460 V 50/60 Hz	D38
480 V 50/60 Hz	D39

## Electronic Monitoring Relays

### Temperature Monitoring with PTC

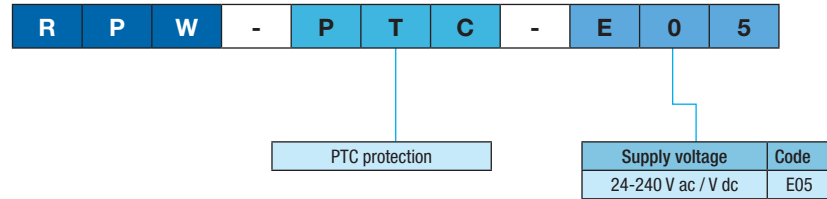

### Multifunction Three-Phase Monitoring Relays

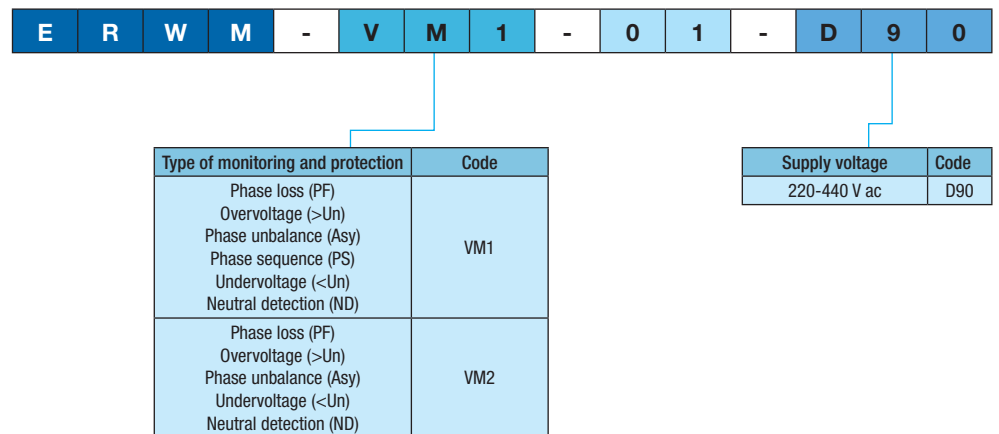

## Electronic Level Control Relay

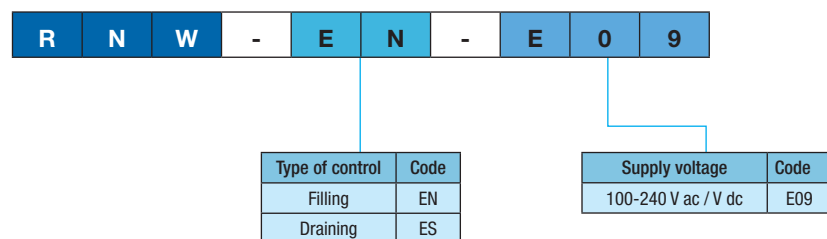

## Miniature Circuit Breakers

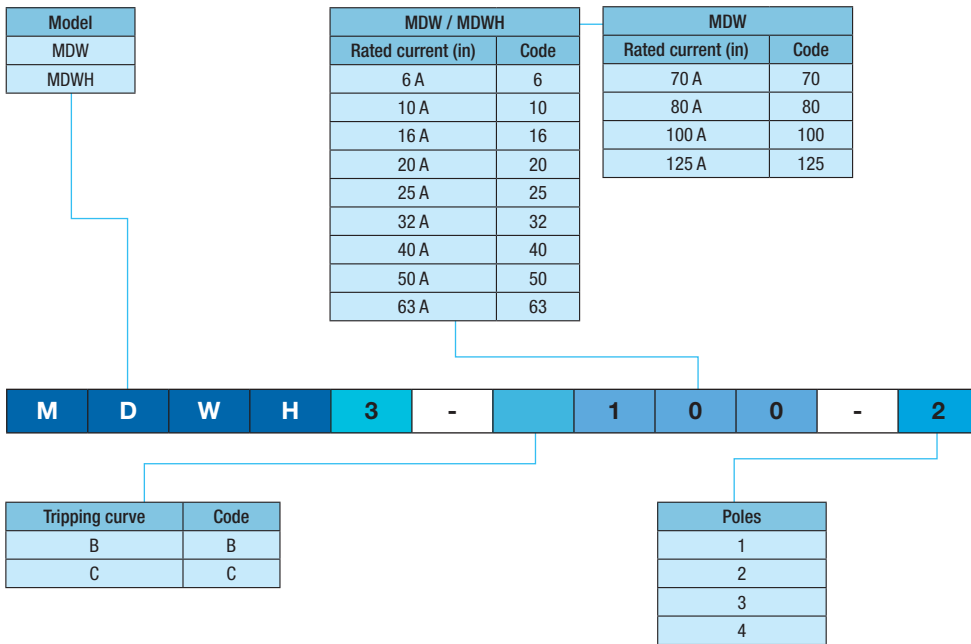

## Miniature Switch Disconnectors

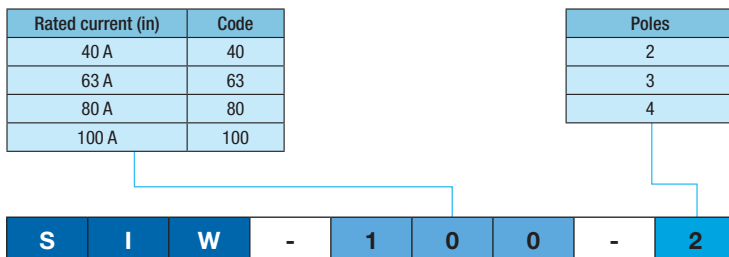

## Residual Current Circuit Breakers (Earth Leakage Switches)

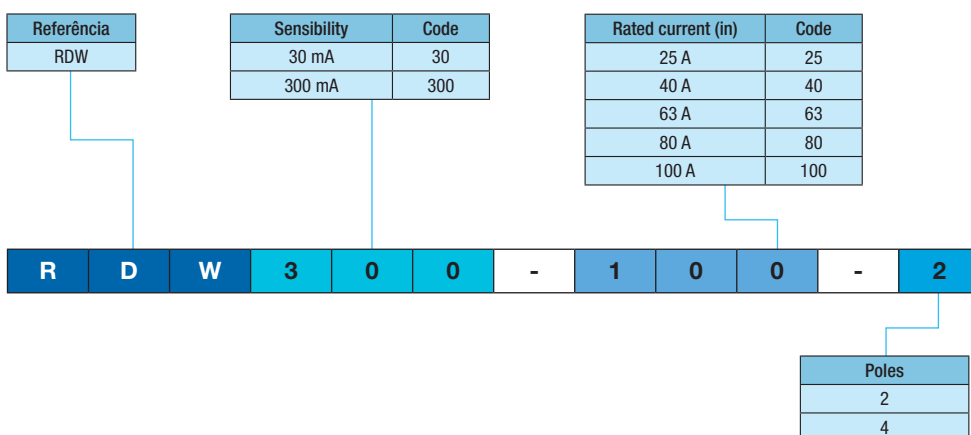

# Molded Case Circuit Breakers

## DWB Line

Model
DWB160
DWB250
DWB400
IWB160 <sup>1)</sup>
IWB250 <sup>1)</sup>
IWB400 <sup>1)</sup>

Rated current (A)		Rated current (A)	
16	90	63	150
20	95	65	160
25	100	70	185
32	105	75	200
40	110	80	250
50	125	85	320
55	140		400



D	W	B	1	6	0	N	2	5	-	3	D	F
---	---	---	---	---	---	---	---	---	---	---	---	---

Breaking capacity at 380-415 V ac	Code
16 kA	B
30/35 kA	N
65 kA	H <sup>3)</sup>
80 kA	L

Poles
2 <sup>2)</sup>
3
4

Type of protection	Trip settings	Code
Distribution	Fixed thermal and magnetic release	DX
	Adjustable thermal and fixed magnetic release	DF
	Adjustable thermal and magnetic release	DA
Motor protection	Fixed magnetic release	MF
	Adjustable magnetic release	MA
Generator protection	Fixed thermal and magnetic release	GX
	Adjustable thermal and fixed magnetic release	GF
	TAdjustable thermal and magnetic releases	GA

## DWA Line

Type of protection	Code
Distribution	DWA
Motor protection	DWM
Generator protection	DWG
Without prot. (switch)	IWA

Breaking capacity at 380-415 V ac	Code
30/35 kA	N
50 kA	S
65 kA	H

Trip unit	Code
Electronic LSI (default for DWA1600)	E
Thermomagnetic (default for DWA800)	Blank

Shunt release	Code
24 V ac / V dc	E26
48 V ac / V dc	E27
60 V ac / V dc	E28
110-130 V ac / V dc	E10
220-250 V ac / V dc	E15
None	0

Undervoltage release	Code
24 V dc	C03
48 V dc	C07
125 V dc	C13
110-127 V ac	D60
200-250 V ac	D66
380-415 V ac	D70
None	0

D	W	A	8	0	0	H	-	E	3	2	0	-	3	-	1	6	6	-	2	1	-	E	15	-	D	6	6
---	---	---	---	---	---	---	---	---	---	---	---	---	---	---	---	---	---	---	---	---	---	---	----	---	---	---	---

Frame
800
1,600

Rated current
320
400
420
500
630
700
800
1,250
1,600

Poles
2 <sup>2)</sup>
3
4 <sup>2)</sup>

Operating handle	Code
MR (short) DWA800-1600	166
MR (long) DWA800-1600	465
MRI	MRI
None	0

Auxiliary contacts BC/AL	Code
AL	01
BC1	10
BC1+AL	11
BC2	20
BC2+AL	21
BC3	30
None	0

Notes: 1) For IWB switches, please disconsider "Breaking capacity" and "Type of protection".  
 2) 2 and 4-pole versions under request.  
 3) DWB400 only.

# Molded Case Circuit Breakers

## ACW Line

Model
ACW100
ACW101 <sup>1)</sup>
ACW160
ACW161 <sup>1)</sup>
ACW250
ACW400
ACW630
ACW800

Breaking capacity	Code
High capacity	H U (ACW800)
Very high capacity <sup>2)</sup>	V

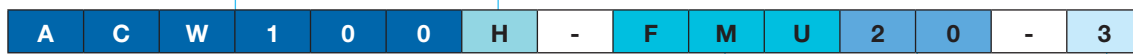

Type of protection	Code
Adjustable thermal and fixed magnetic release	FMU
Adjustable thermal and magnetic releases	ATU
Electronic LSI	ETS
Magnetic only - motor protection	MTU

Rated current (A)	Rated current (A)
20	100
25	125
32	160
40	200
50	400
63	630
80	800

Poles
3

Notes: 1) MTU protection only.  
2) Up to ACW630.





# Switch-Disconnectors

## Compact Switch-Disconnectors with Red-Yellow Handle<sup>1)</sup>

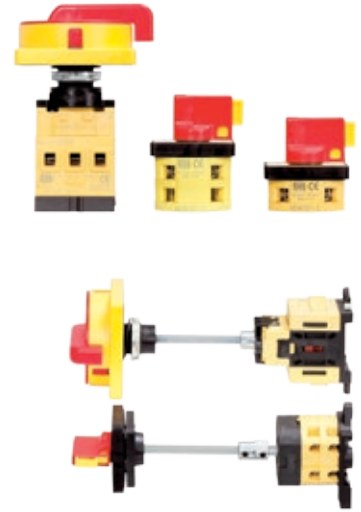
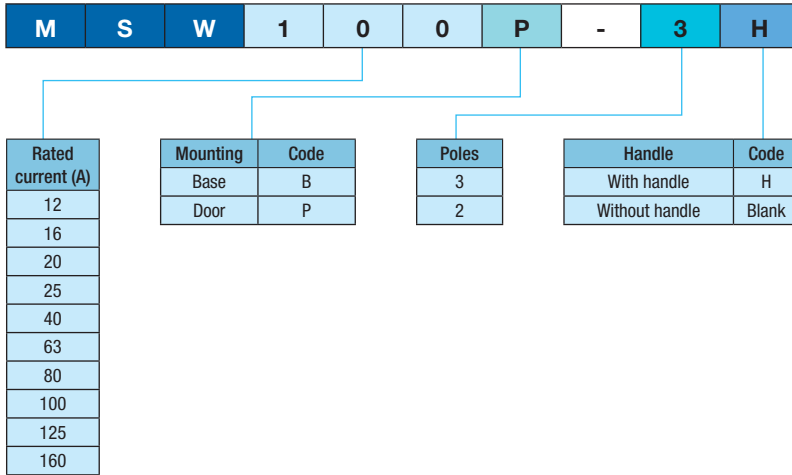

## Fuse Switch-Disconnectors

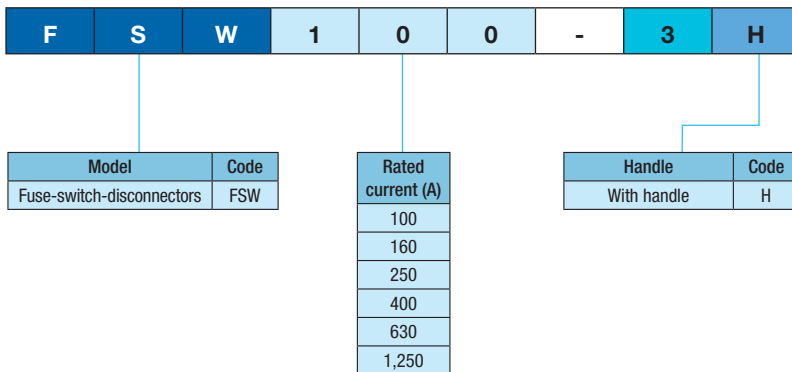

Note: 1) Black-gray handle available upon request.



# Fuses

## gL/GG Fuses - D and NH (Blade Contact) Types

Fuse type	Code
D type	FDW
NH type	FNH

Size for NH fuses <sup>1)</sup>
000
00
1
2
3



F	N	H		2	-	6	3	0	U
---	---	---	--	---	---	---	---	---	---

Rated current (A)	Rated current (A)
2	125
4	160
6	200
10	224
16	250
20	300
25	315
35	355
50	400
63	425
80	500
100	630

Breaking capacity	Fuse type	Code
120 kA	NH type	U
50 kA	D type	S

## High Speed - aR Type - Fuses NH

Size	Code
00	00
1	1
2	2
3	3
2X3 (FEA)	23

Constructive characteristics	Code
Metric flush end (terminal with metric thread)	FEM
Metric flush end 2X3 with busbar in one side	FEA
Blade contact	Blank

Rated current (A)	Rated current (A)
20	450
25	500
35	550
40	630
50	700
63	710
80	800
100	900
125	1,000
160	1,100
200	1,250
250	1,400
315	1,600
350	1,800
400	2,000

Breaking capacity	Code
200 kA	Y
100 kA	K



F	N	H	3	F	E	M	-	1	0	0	0	Y	-	A
---	---	---	---	---	---	---	---	---	---	---	---	---	---	---

Type	Code
aR	A

Note: 1) For D type fuses keep it blank.

# Capacitors for Power Factor Correction

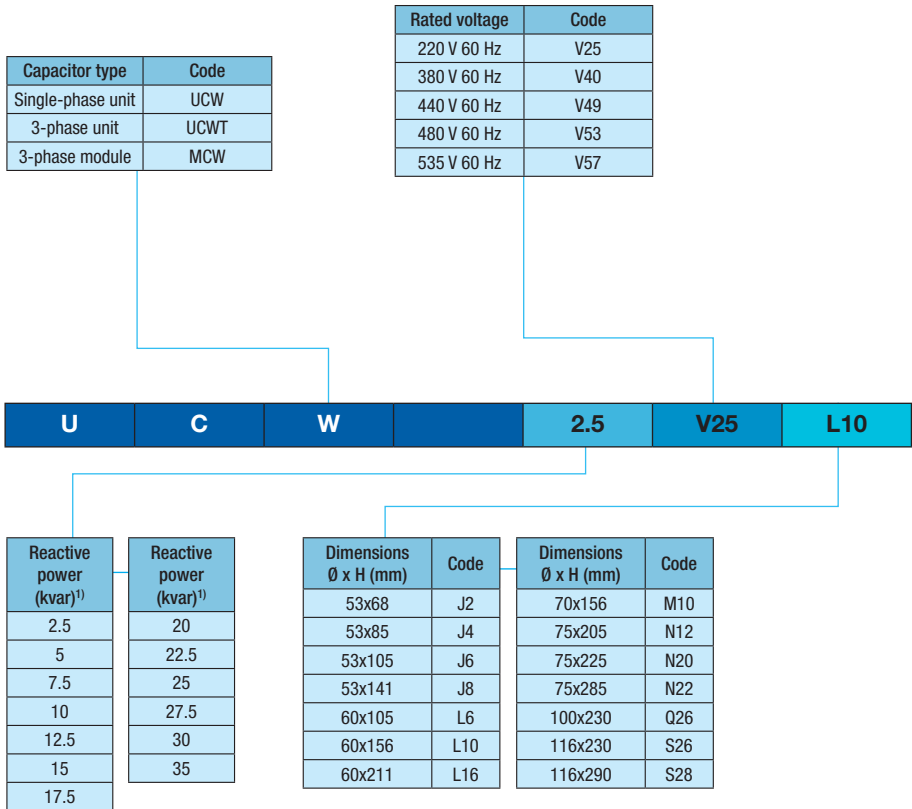

Valid only for models UCW and UCWT



Note: 1) When selecting the reactive power (kvar) it is important to keep in mind the network frequency and voltage. For further information check the Power Factor Correction catalogue at [www.weg.net](http://www.weg.net).



# Air Circuit Breakers

Maximum rated current	Code
800 A	08
1,600 A	16
2,000 A	20
2,500 A	25
3,200 A	32
4,000 A	40
5,000 A	50
6,300 A	63

Frame size	Code
For 1,600 A	DN
For 2,000~3,200 A	ES
For 4,000~5,000 A	FS
For 6,300 A	GS

Opening coil	Code
200~250 V ac/dc (default)	2
No coil	0
100~130 V ac/dc	1
24~30 V dc	3
48~60 V dc	4
380~480 V ac	5

Accessories	Code
None (default)	Blank
ON/OFF button lock	B
Key lock for 1 ACB	K
Key interlock for 3 ACBs	K2
Mechanical interlock (2 breakers)	M
Mechanical interlock (3 breakers)	M3
Door interlock	D
B+K	BK
B+K2	B2
B+M	BM
B+D	BD
K+M	KM
K+D	KD
Profibus communication <sup>1)</sup>	CP
Modbus communication <sup>1)</sup>	CM

Poles
3
4

Version	Code
Fixed	F
Withdrawable	E

**A B W 1 6 D N 3 - 1 6 A Z 1 F - A 0 2 2 0**

Rated current	Code
800 A	08
1,600 A	16
2,000 A	20
2,500 A	25
3,200 A	32
4,000 A	40
5,000 A	50
6,300 A	63

Auxiliary contacts	Code
5NO+5NC (default)	A
Position auxiliary contacts (for withdrawable version)	B

Motorized operator	Code
None (default)	0
100~130 V ac/dc	1
200~250 V ac/dc	2
24~30 V dc	3
48~60 V dc	4
380 V ac	5
480 V ac	6

Closing coil	Code
200~250 V ac/dc (default)	2
No coil	0
100~130 V ac/dc	1
24~30 V dc	3
48~60 V dc	4
380~480 V dc	5

Undervoltage release	Code
None (default)	0
100~130 V ac/dc	1
200~250 V ac/dc	2
24~30 V dc	3
48~60 V dc	4
380~480 V ac	5
200~250 V ac/dc with delay	6
100~130 V ac/dc with delay	7
48~60 V dc with delay	8
380~480 V ac with delay	9

Protection and measurement unit <sup>2)</sup>	Code
LSIG + A <sup>3)</sup> (100~250 V ac/dc, 60 Hz) - default	AZ1
No protection unit	000
LSI + A <sup>3)</sup> (100~250 V ac/dc, 60 Hz) + Earth leakage <sup>5)</sup>	AF1
LSI + A <sup>3)</sup> (100~250 V ac/dc, 50 Hz) + Earth leakage <sup>5)</sup>	AF6
LSIG + A <sup>3)</sup> + Communication (100~250 V ac/dc, 60 Hz)	AC1
LSIG + A <sup>3)</sup> + Communication (100~250 V ac/dc, 50 Hz)	AC6
LSIG + A <sup>3)</sup> + Communication 24~60 V dc	AC2
LSIG + M <sup>4)</sup> + Communication (100~250 V ac/dc, 60 Hz)	PC1
LSIG + M <sup>4)</sup> + Communication (100~250 V ac/dc, 50 Hz)	PC6
LSIG + V + A <sup>3)</sup> + Communication 24~60 V dc	PC2
LSIG + A <sup>3)</sup> 24~60 V dc	AZ2
LSIG + A <sup>3)</sup> (100~250 V ac/dc, 50 Hz)	AZ6

Accessories supplied as standard for the entire range
Auxiliary contacts (5NO+5NC)
Alarm contacts
Opening coil 200-250 V ac/dc
Closing coil 200-250 V ac/dc
Operation counter
Position locking with padlock (padlock not included) - withdrawable version only
Position indicator (inserted /test/ withdrawn) - withdrawable version only



Notes: 1) To be used with circuit breakers that have protection units type AC or PC.  
 2) For further information about protection units, check the catalogue at WEG website.  
 3) A - Current measurement.  
 4) M - Current, voltage, power and frequency measurements.  
 5) The current transformer ABW-ZCT must be used for earth leakage protection (supplied as accessory).

## Voltage Codes - Controls

### Alternating Current

Supply voltage	Code
10 V 50 Hz / 12 V 60 Hz	V01
12 V 50 Hz / 14 V 60 Hz	V02
16 V 50 Hz / 20 V 60 Hz	V03
20 V 50 Hz / 24 V 60 Hz	V04
24 V 60 Hz	V05
24 V 50 Hz / 28 V 60 Hz	V06
28 V 50 Hz / 32 V 60 Hz	V07
32 V 50 Hz / 36 V 60 Hz	V08
36 V 50 Hz / 42 V 60 Hz	V09
42 V 50 Hz / 48 V 60 Hz	V10
48 V 50 Hz / 56 V 60 Hz	V11
52 V 50 Hz / 60 V 60 Hz	V12
75 V 60 Hz	V13
70 V 50 Hz / 80 V 60 Hz	V14
95 V 50 Hz / 110 V 60 Hz	V15
110 V 60 Hz	V16
100 V 50 Hz / 115 V 60 Hz	V17
110 V 50 Hz / 120 V 60 Hz	V18
110-115 V 50 Hz / 127 V 60 Hz	V19
120 V 50 Hz / 140 V 60 Hz	V20
127 V 50 Hz / 150 V 60 Hz	V21
139 V 50 Hz / 160 V 60 Hz	V22
180 V 50 Hz / 208 V 60 Hz	V23
180-208 V 50 Hz / 208-240 V 60 Hz	V24
220 V 60 Hz	V25
190 V 50 Hz / 220 V 60 Hz	V26
230 V 60 Hz	V27
200 V 50 Hz / 230 V 60 Hz	V28
240 V 60 Hz	V29
208 V 50 Hz / 240 V 60 Hz	V30
220 V 50 Hz	V31
220 V 50 Hz / 255 V 60 Hz	V32
220-230 V 50 Hz / 240-260 V 60 Hz	V33
230 V 50 Hz	V34
250 V 50 Hz	V35
230 V 50 Hz / 266 V 60 Hz	V36

Supply voltage	Code
230-240 V 50 Hz / 277 V 60 Hz	V37
250 V 60 Hz	V38
310 V 60 Hz	V39
380 V 60 Hz	V40
325 V 50 Hz / 380 V 60 Hz	V41
380 V 50 Hz / 440 V 60 Hz	V42
380-400 V 50 Hz / 440-460 V 60 Hz	V43
400 V 50 Hz	V44
400 V 60 Hz	V45
400 V 50 Hz / 460 V 60 Hz	V46
400-415 V 50 Hz / 480 V 60 Hz	V47
440 V 50 Hz	V48
440 V 60 Hz	V49
440 V 50 Hz / 510 V 60 Hz	V50
460 V 50 Hz	V51
480 V 50 Hz	V52
480 V 60 Hz	V53
500 V 50 Hz	V54
500 V 60 Hz	V55
500 V 50 Hz / 600 V 60 Hz	V56
535 V 60 Hz	V57
550 V 50 Hz	V58
550 V 60 Hz	V59
550 V 50 Hz / 660 V 60 Hz	V60
575 V 60 Hz	V61
660 V 60 Hz	V62
600 V 50 Hz / 690 V 60 Hz	V63

Supply voltage	Code
12 V 50/60 Hz	D01
24 V 50/60 Hz	D02
28 V 50/60 Hz	D03
32 V 50/60 Hz	D04
36 V 50/60 Hz	D05
42 V 50/60 Hz	D06
48 V 50/60 Hz	D07
56 V 50/60 Hz	D08
60 V 50/60 Hz	D09
72 V 50/60 Hz	D10
80 V 50/60 Hz	D11
100 V 50/60 Hz	D12
110 V 50/60 Hz	D13
115 V 50/60 Hz	D14
120 V 50/60 Hz	D15
125 V 50/60 Hz	D16
127 V 50/60 Hz	D17
130 V 50/60 Hz	D18
140 V 50/60 Hz	D19
150 V 50/60 Hz	D20
190 V 50/60 Hz	D21
200 V 50/60 Hz	D22
220 V 50/60 Hz	D23
230 V 50/60 Hz	D24
240 V 50/60 Hz	D25
250 V 50/60 Hz	D26
255 V 50/60 Hz	D27
265 V 50/60 Hz	D28
270 V 50/60 Hz	D29
330 V 50/60 Hz	D30
350 V 50/60 Hz	D31
370 V 50/60 Hz	D32
380 V 50/60 Hz	D33
400 V 50/60 Hz	D34
415 V 50/60 Hz	D35
440 V 50/60 Hz	D36
450 V 50/60 Hz	D37
460 V 50/60 Hz	D38
480 V 50/60 Hz	D39

## Voltage Codes - Controls

### Alternating Current (50/60 Hz)

Supply voltage	Code
500 V 50/60 Hz	D40
510 V 50/60 Hz	D41
525 V 50/60 Hz	D42
550 V 50/60 Hz	D43
575 V 50/60 Hz	D44
600 V 50/60 Hz	D45
630 V 50/60 Hz	D46
660 V 50/60 Hz	D47
690 V 50/60 Hz	D48
12-24 V 50/60 Hz	D49
12-60 V 50/60 Hz	D50
20-24 V 50/60 Hz	D51
24-28 V 50/60 Hz	D52
24-48 V 50/60 Hz	D53
40-48 V 50/60 Hz	D54
48-127 V 50/60 Hz	D55
50-250 V 50/60 Hz	D56
72-250 V 50/60 Hz	D57
100-110 V 50/60 Hz	D58
100-127 V 50/60 Hz	D59
110-127 V 50/60 Hz	D60
110-130 V 50/60 Hz	D61
110-220 V 50/60 Hz	D62
127-250 V 50/60 Hz	D63
200-220 V 50/60 Hz	D64
200-240 V 50/60 Hz	D65
220-240 V 50/60 Hz	D66
250-380 V 50/60 Hz	D67
270-380 V 50/60 Hz	D68
365-440 V 50/60 Hz	D69
380-415 V 50/60 Hz	D70
380-440 V 50/60 Hz	D71
380-510 V 50/60 Hz	D72
400-510 V 50/60 Hz	D73
440-480 V 50/60 Hz	D74
500-510 V 50/60 Hz	D75
660-690 V 50/60 Hz	D76
208 V 50/60 Hz	D77

### Direct Current

Supply voltage	Code
5 V dc	C01
12 V dc	C02
24 V dc	C03
28 V dc	C04
36 V dc	C05
42 V dc	C06
48 V dc	C07
55 V dc	C08
60 V dc	C09
72 V dc	C10
80 V dc	C11
110 V dc	C12
125 V dc	C13
130 V dc	C14
220 V dc	C15
230 V dc	C16
250 V dc	C17
400 V dc	C18
415 V dc	C19
440 V dc	C20
500 V dc	C21
600 V dc	C22
1,000 V dc	C23
1,200 V dc	C24
6-240 V dc	C31
6-250 V dc	C32
12-600 V dc	C33
24-28 V dc	C34
24-48 V dc	C35
24-240 V dc	C36
42-50 V dc	C37
48-260 V dc	C38
100-125 V dc	C39
110-130 V dc	C40
120-127 V dc	C41
130-250 V dc	C42
200-240 V dc	C43
208-240 V dc	C44
208-250 V dc	C45
230-240 V dc	C46
150 V dc	C47
42-48 V dc	C97
110-125 V dc	C98
220-250 V dc	C99

### Alternating Current / Direct Current

Supply voltage	Code
12-48 V dc 50/60 Hz	E01
24-28 V dc 50/60 Hz	E02
24-48 V dc 50/60 Hz	E03
24-60 V dc 50/60 Hz	E04
24-240 V dc 50/60 Hz	E05
42-50 V dc 50/60 Hz	E06
60-72 V dc 50/60 Hz	E07
100-125 V dc 50/60 Hz	E08
100-240 V dc 50/60 Hz	E09
110-130 V dc 50/60 Hz	E10
110-220 V dc 50/60 Hz	E11
200-240 V dc 50/60 Hz	E12
208-250 V dc 50/60 Hz	E13
220-240 V dc 50/60 Hz	E14
220-250 V dc 50/60 Hz	E15
360-415 V dc 50/60 Hz	E16
265-347 V dc 50/60 Hz	E17
380-415 V dc 50/60 Hz	E18
380-450 V dc 50/60 Hz	E19
400-500 V dc 50/60 Hz	E20
430-500 V dc 50/60 Hz	E21
440-500 V dc 50/60 Hz	E22
440-575 V dc 50/60 Hz	E23
575-690 V dc 50/60 Hz	E24
12 V dc 50/60 Hz	E25
24 V dc 50/60 Hz	E26
48 V dc 50/60 Hz	E27
60 V dc 50/60 Hz	E28
110 V dc 50/60 Hz	E29
130 V dc 50/60 Hz	E30
220 V dc 50/60 Hz	E31
380 V dc 50/60 Hz	E32
48 V 50/60 Hz / 24Vdc	E33
50-127 V 50/60 Hz / 60-180 V dc	E34
100-127 V 50/60 Hz / 100-110 V dc	E35
100-240 V 50/60 Hz / 100-220 V dc	E36
110-130 V 50/60 Hz / 24 V dc	E37
130-275 V 50/60 Hz / 180-300 V dc	E38
200-240 V 50/60 Hz / 200-220 V dc	E39
220-240 V 50/60 Hz / 24 V dc	E40
277-380 V 50/60 Hz / 300-510 V dc	E41
430-525 V dc 50/60 Hz	E42
208-240 V dc 50/60 Hz	E43
220-240 V 50/60 Hz / 250 V dc	E44
100-110 V 50/60 Hz / 110 V dc	E45
230 V 50/60 Hz / 220 V dc	E46

## Short Codes for Overload Relays to be Used on Enclosed Direct On Line Starters

Description	Code	Setting range
RW17-1D3-D004	R01	0.28 - 0.4
RW17-1D3-C063	R02	0.4 - 0.63
RW17-1D3-D008	R03	0.56 - 0.8
RW17-1D3-D012	R04	0.8 - 1.2
RW17-1D3-D018	R05	1.2 - 1.8
RW17-1D3-D028	R06	1.8 - 2.8
RW17-1D3-U004	R07	2.8 - 4
RW17-1D3-D063	R08	4.0 - 6.3
RW17-1D3-U008	R09	5.6 - 8
RW17-1D3-U010	R10	7 - 10
RW17-1D3-D125	R11	8 - 12.5
RW17-1D3-U015	R12	10 - 15
RW17-1D3-U017	R13	11 - 17
RW27-1D3-C063	R21	0.4 - 0.63
RW27-1D3-D008	R22	0.56 - 0.8
RW27-1D3-D012	R23	0.8 - 1.2
RW27-1D3-D018	R24	1.2 - 1.8
RW27-1D3-D028	R25	1.8 - 2.8
RW27-1D3-U004	R26	2.8 - 4
RW27-1D3-D063	R27	4.0 - 6.3
RW27-1D3-U008	R28	5.6 - 8
RW27-1D3-U010	R29	7 - 10
RW27-1D3-D125	R30	8 - 12.5
RW27-1D3-U015	R31	10 - 15
RW27-1D3-U017	R32	11 - 17
RW27-1D3-U023	R33	15 - 23
RW27-1D3-U032	R34	22 - 32
RW67-1D3-U040	R35	25 - 40
RW67-1D3-U050	R37	40 - 57
RW67-2D3-U050	R38	40 - 57
RW67-2D3-U057	R39	50 - 63
RW67-2D3-U063	R40	57 - 70
RW67-2D3-U070	R41	63 - 80
RW67-2D3-U080	R42	63 - 80
RW117-1D3-U097	R44	75 - 97
RW117-1D3-U112	R45	90 - 112

Description	Code	Setting range
RW17-1D2-D018	RM05	1.2 - 1.8
RW17-1D2-D028	RM06	1.8 - 2.8
RW17-1D2-U004	RM07	2.8 - 4
RW17-1D2-D063	RM08	4 - 6.3
RW27-1D2-D008	RM22	0.56 - 0.8
RW27-1D2-D012	RM23	0.8 - 1.2
RW27-1D2-D018	RM24	1.2 - 1.8
RW27-1D2-D028	RM25	1.8 - 2.8
RW27-1D2-U004	RM26	2.8 - 4
RW27-1D2-D063	RM27	4 - 6.3
RW27-1D2-U008	RM28	5.6 - 8
RW27-1D2-U010	RM29	7 - 10
RW27-1D2-D125	RM30	8 - 12.5
RW27-1D2-U015	RM31	10 - 15
RW27-1D2-U017	RM32	11 - 17
RW27-1D2-U023	RM33	15 - 23
RW27-1D2-U032	RM34	22 - 32
RW67-1D2-U040	RM35	25 - 40
RW67-2D2-U050	RM38	32 - 50
RW67-2D2-U057	RM39	40 - 57
RW67-2D2-U063	RM40	50 - 63
RW67-2D2-U070	RM41	57 - 70

# WEG Worldwide Operations

## ARGENTINA

San Francisco - Cordoba  
Phone: +54 3564 421484  
[info-ar@weg.net](mailto:info-ar@weg.net)

Cordoba - Cordoba  
Phone: +54 351 4641366  
[weg-morbe@weg.com.ar](mailto:weg-morbe@weg.com.ar)

Buenos Aires  
Phone: +54 11 42998000  
[ventas@pulverlux.com.ar](mailto:ventas@pulverlux.com.ar)

## AUSTRALIA

Scoresby - Victoria  
Phone: +61 3 97654600  
[info-au@weg.net](mailto:info-au@weg.net)

## AUSTRIA

Markt Piesting - Wiener  
Neustadt-Land  
Phone: +43 2633 4040  
[watt@wattdrive.com](mailto:watt@wattdrive.com)

## BELGIUM

Nivelles - Belgium  
Phone: +32 67 888420  
[info-be@weg.net](mailto:info-be@weg.net)

## BRAZIL

Jaraguá do Sul - Santa Catarina  
Phone: +55 47 32764000  
[info-br@weg.net](mailto:info-br@weg.net)

## CHILE

La Reina - Santiago  
Phone: +56 2 27848900  
[info-cl@weg.net](mailto:info-cl@weg.net)

## CHINA

Nantong - Jiangsu  
Phone: +86 513 85989333  
[info-cn@weg.net](mailto:info-cn@weg.net)

Changzhou - Jiangsu  
Phone: +86 519 88067692  
[info-cn@weg.net](mailto:info-cn@weg.net)

## COLOMBIA

San Cayetano - Bogota  
Phone: +57 1 4160166  
[info-co@weg.net](mailto:info-co@weg.net)

## ECUADOR

El Batan - Quito  
Phone: +593 2 5144339  
[ceccato@weg.net](mailto:ceccato@weg.net)

## FRANCE

Saint-Quentin-Fallavier - Isère  
Phone: +33 4 74991135  
[info-fr@weg.net](mailto:info-fr@weg.net)

## GERMANY

Türnich - Kerpen  
Phone: +49 2237 92910  
[info-de@weg.net](mailto:info-de@weg.net)

Balingen - Baden-Württemberg  
Phone: +49 7433 90410  
[info@weg-antriebe.de](mailto:info@weg-antriebe.de)

Homburg (Efze) - Hesse  
Phone: +49 5681 99520  
[info@akh-antriebstechnik.de](mailto:info@akh-antriebstechnik.de)

## GHANA

Accra  
Phone: +233 30 2766490  
[info@zestghana.com.gh](mailto:info@zestghana.com.gh)

## INDIA

Bangalore - Karnataka  
Phone: +91 80 41282007  
[info-in@weg.net](mailto:info-in@weg.net)

Hosur - Tamil Nadu  
Phone: +91 4344 301577  
[info-in@weg.net](mailto:info-in@weg.net)

## ITALY

Cinisello Balsamo - Milano  
Phone: +39 2 61293535  
[info-it@weg.net](mailto:info-it@weg.net)

## JAPAN

Yokohama - Kanagawa  
Phone: +81 45 5503030  
[info-jp@weg.net](mailto:info-jp@weg.net)

## MALAYSIA

Shah Alam - Selangor  
Phone: +60 3 78591626  
[info@wattdrive.com.my](mailto:info@wattdrive.com.my)

## MEXICO

Huehuetoca - Mexico  
Phone: +52 55 53214275  
[info-mx@weg.net](mailto:info-mx@weg.net)

Tizayuca - Hidalgo  
Phone: +52 77 97963790

## NETHERLANDS

Oldenzaal - Overijssel  
Phone: +31 541 571080  
[info-nl@weg.net](mailto:info-nl@weg.net)

## PERU

La Victoria - Lima  
Phone: +51 1 2097600  
[info-pe@weg.net](mailto:info-pe@weg.net)

## PORTUGAL

Maia - Porto  
Phone: +351 22 9477700  
[info-pt@weg.net](mailto:info-pt@weg.net)

## RUSSIA and CIS

Saint Petersburg  
Phone: +7 812 363 2172  
[sales-wes@weg.net](mailto:sales-wes@weg.net)

## SOUTH AFRICA

Johannesburg  
Phone: +27 11 7236000  
[info@zest.co.za](mailto:info@zest.co.za)

## SPAIN

Coslada - Madrid  
Phone: +34 91 6553008  
[wegiberia@wegiberia.es](mailto:wegiberia@wegiberia.es)

## SINGAPORE

Singapore  
Phone: +65 68589081  
[info-sg@weg.net](mailto:info-sg@weg.net)

Singapore  
Phone: +65 68622220  
[watteuro@watteuro.com.sg](mailto:watteuro@watteuro.com.sg)

## SCANDINAVIA

Mölnlycke - Sweden  
Phone: +46 31 888000  
[info-se@weg.net](mailto:info-se@weg.net)

## UK

Redditch - Worcestershire  
Phone: +44 1527 513800  
[info-uk@weg.net](mailto:info-uk@weg.net)

## UNITED ARAB EMIRATES

Jebel Ali - Dubai  
Phone: +971 4 8130800  
[info-ae@weg.net](mailto:info-ae@weg.net)

## USA

Duluth - Georgia  
Phone: +1 678 2492000  
[info-us@weg.net](mailto:info-us@weg.net)

Minneapolis - Minnesota  
Phone: +1 612 3788000

## VENEZUELA

Valencia - Carabobo  
Phone: +58 241 8210582  
[info-ve@weg.net](mailto:info-ve@weg.net)

For those countries where there is not a WEG own operation, find our local distributor at [www.weg.net](http://www.weg.net).



WEG Group - Automation Business Unit  
Jaraguá do Sul - SC - Brazil  
Phone: +55 47 3276 4000  
[automacao@weg.net](mailto:automacao@weg.net)  
[www.weg.net](http://www.weg.net)

