

IEC Limit Switches Selection Guide

ABM Series



ABP Series



AAP Series



Series	ABM Series	ABP Series	AAP Series
Prices start at	<--->	<--->	<--->
Description	Heavy duty IEC	Double-insulated, non-metallic IEC	Double-insulated, non-metallic mini-DIN IEC
Material of Construction	Aluminum	PBT (plastic)	PBT (plastic)
Degree of Protection (IEC529)	IEC IP66	IEC IP65	IEC IP65
Maximum Switching Frequency	Contact blocks: all two cycles per second	Contact blocks: all two cycles per second	Contact blocks: all two cycles per second
Mechanical Service Life	25 million cycles	25 million cycles	25 million cycles
Contact Configuration	One snap-action set of N.O. / N.C. contacts. (Optional contact blocks with other configurations are available)	One snap-action set of N.O. / N.C. contacts. (Optional contact blocks with other configurations are available)	One snap-action set of N.O. / N.C. contacts. (Optional contact blocks with other configurations are available)
Conduit Opening	One and three cable holes, PG 13.5 or 1/2 NPT	One cable hole, PG 13.5 or 1/2 NPT	One cable hole, PG 11 or 1/2 NPT
Connection	2x2.5mm ² (AWG14) to 2x0.5mm ² (AWG 18)	2x2.5mm ² (AWG14) to 2x0.5mm ² (AWG 18)	2x2.5mm ² (AWG14) to 2x0.5mm ² (AWG 18)
Agency Approvals	CE markings for applicable CE Directives (CEE 73/23, CEE 93/68, EN60947.1, EN60947.5.1), UL certified (UL508), File E191072	CE markings for applicable CE Directives (CEE 73/23, CEE 93/68, EN60947.1, EN60947.5.1), UL certified (UL508), File E191072	CE markings for applicable CE Directives (CEE 73/23, CEE 93/68, EN60947.1, EN60947.5.1), UL certified (UL508), File E191072

IEC Limit Switches

ABM series heavy-duty IEC limit switches

- Featuring a diecast aluminum body for heavy-duty industrial applications
- Single and multiple conduit openings to save wiring time and money when interconnecting several limit switches
- Conduit openings in 1/2" NPT or PG13.5
- Splined actuator shaft allows very fine adjustment of switch to fit all applications
- Choose from eight different actuators including roller levers and plungers

ABM Series									
Part Number	Price	Actuator Type	No. of Conduit Holes	Conduit Threads	Max. Actuation Speed (m/s)	Min. Actuation Force (N) /Torque (Nm)	Min. Positive Opening Force (N) /Torque (Nm)	Dimensions: Body / Head	Photo
ABM1E11Z11	<--->	Stainless steel plunger	One	PG13.5	0.5	30(N)	45(N)	Figures 1, 5	A
ABM2E11Z11	<--->		One	1/2" NPT	0.5	30(N)	45(N)	Figures 1, 5	A
ABM5E11Z11	<--->		Three	PG13.5	0.5	30(N)	45(N)	Figures 2, 5	B
ABM6E11Z11	<--->		Three	NPT	0.5	30(N)	45(N)	Figures 2, 5	B
ABM1E13Z11	<--->	Stainless steel plunger with roller	One	PG13.5	0.5	22(N)	40(N)	Figures 1, 6	C
ABM2E13Z11	<--->		One	1/2" NPT	0.5	22(N)	40(N)	Figures 1, 6	C
ABM5E13Z11	<--->		Three	PG13.5	0.5	22(N)	40(N)	Figures 2, 6	D
ABM6E13Z11	<--->		Three	1/2" NPT	0.5	22(N)	40(N)	Figures 2, 6	D
ABM1E32Z11	<--->	One-way lever with stainless steel roller	One	PG13.5	1.5	12(N)	40(N)	Figures 1, 7	E
ABM2E32Z11	<--->		One	1/2" NPT	1.5	12(N)	40(N)	Figures 1, 7	E
ABM5E32Z11	<--->		Three	PG13.5	1.5	12(N)	40(N)	Figures 2, 7	F
ABM6E32Z11	<--->		Three	1/2" NPT	1.5	12(N)	40(N)	Figures 2, 7	F
ABM1E42Z11	<--->	Rotary lever with stain. steel roller (See accessories for opt. roller and actuator levers)	One	PG13.5	1.5	0.15(Nm)	0.30(Nm)	Figures 1, 8	G
ABM2E42Z11	<--->		One	1/2" NPT	1.5	0.15(Nm)	0.30(Nm)	Figures 1, 8	G
ABM5E42Z11	<--->		Three	PG13.5	1.5	0.15(Nm)	0.30(Nm)	Figures 2, 8	H
ABM6E42Z11	<--->		Three	1/2" NPT	1.5	0.15(Nm)	0.30(Nm)	Figures 2, 8	H
ABM1E52Z11	<--->	Adj. rotary lever w/ stainless steel roller (See accessories for opt. roller and actuator levers)	One	PG13.5	1.5	0.15(Nm)	0.30(Nm)	Figures 1, 9	I
ABM2E52Z11	<--->		One	1/2" NPT	1.5	0.15(Nm)	0.30(Nm)	Figures 1, 9	I
ABM5E52Z11	<--->		Three	PG13.5	1.5	0.15(Nm)	0.30(Nm)	Figures 2, 9	J
ABM6E52Z11	<--->		Three	NPT	1.5	0.15(Nm)	0.30(Nm)	Figures 2, 9	J
ABM1E71Z11	<--->	Adjustable rotary lever w/ stainless steel rod	One	PG13.5	1.5	0.15(Nm)	0.30(Nm)	Figures 1, 10	K
ABM2E71Z11	<--->		One	1/2" NPT	1.5	0.15(Nm)	0.30(Nm)	Figures 1, 10	K
ABM5E71Z11	<--->		Three	PG13.5	1.5	0.15(Nm)	0.30(Nm)	Figures 2, 10	L
ABM6E71Z11	<--->		Three	1/2" NPT	1.5	0.15(Nm)	0.30(Nm)	Figures 2, 10	L
ABM1E92Z11	<--->	Wobble lever w/ polyamide tip stainless steel spring	One	PG13.5	1.0	0.18(Nm)	-	Figures 1, 11	M
ABM2E92Z11	<--->		One	1/2" NPT	1.0	0.18(Nm)	-	Figures 1, 11	M
ABM5E92Z11	<--->		Three	PG13.5	1.0	0.18(Nm)	-	Figures 2, 11	N
ABM6E92Z11	<--->		Three	1/2" NPT	1.0	0.18(Nm)	-	Figures 2, 11	N
ABM1E93Z11	<--->	Wobble lever w/stainless steel spring	One	PG13.5	1.0	0.18(Nm)	-	Figures 1, 12	O
ABM2E93Z11	<--->		One	1/2" NPT	1.0	0.18(Nm)	-	Figures 1, 12	O
ABM5E93Z11	<--->		Three	PG13.5	1.0	0.18(Nm)	-	Figures 2, 12	P
ABM6E93Z11	<--->		Three	1/2" NPT	1.0	0.18(Nm)	-	Figures 2, 12	P



- Company Information
- Systems Overview
- Programmable Controllers
- Field I/O
- Software
- C-more & other HMI
- Drives
- Soft Starters
- Motors & Gearbox
- Steppers/ Servos
- Motor Controls
- Proximity Sensors
- Photo Sensors
- Limit Switches
- Encoders
- Current Sensors
- Pressure Sensors
- Temperature Sensors
- Pushbuttons/ Lights
- Process
- Relays/ Timers
- Comm.
- Terminal Blocks & Wiring
- Power
- Circuit Protection
- Enclosures
- Tools
- Pneumatics
- Appendix
- Product Index
- Part # Index

IEC Limit Switches Accessories

Replacement contact blocks

Easily-installed replacement contact blocks fit both heavy-duty IEC and double-insulated limit switches, including mini-DIN models.

Note: Limit switches come standard with snap-action contacts (AGZ11-SWITCH.) To replace contact block, remove limit switch cover. Carefully remove old contact block and install replacement. Contact blocks are supplied with an adapter to fit into larger ABM and ABP switches. Remove this adapter when installing contacts in mini-DIN AAP models.



Replacement Contact Blocks			
Part Number	Price	Contact Type	Action
AGZ11-SWITCH	<-->	Snap action 1 N.C. and N.O.	3ms change-over time
AGZ02-SWITCH	<-->	Snap action 2 N.C.	3ms change-over time
AGX11-SWITCH	<-->	Slow action 1 N.C. and 1 N.O.	Break before make
AGY11-SWITCH	<-->	Slow action overlay 1 N.C. and 1 N.O.	Make before break
AGW02-SWITCH	<-->	Slow action delay 2 N.C.	Simultaneous
AGW20-SWITCH	<-->	Slow action overlay 2 N.O.	Simultaneous

Additional lever arms, spare parts and accessories for ABM series

Additional Lever Arms/Spare Parts and Accessories			
Part Number	Price	Dimensions	Actuator Type
AGE42-LEVER	<-->	Figure 8	Lever with stainless steel roller for E42 models (replacement lever)
AGE44-LEVER	<-->	Figure 13	Lever with 50mm diameter rubber roller (fits E42 models)
AGE52-LEVER	<-->	Figure 9	Lever with stainless steel roller for E52 models (replacement lever)
AGE54-LEVER	<-->	Figure 14	Lever with 50mm diameter rubber roller (fits E52 models)

Note: See the Bar Charts page of this section for more information.



Replacement actuator levers for heavy-duty IEC models

Easily-replaceable actuators for E42 and E52 model limit switches.

Note: These models have an E42 or E52 in the part number, for example, ABM1E42Z11.



AGE52-LEVER

(Replacement lever shown installed on ABM5E52Z11 limit switch)

AGE44-LEVER



AGE54-LEVER

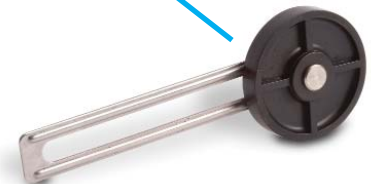

General Specifications



Company Information

Systems Overview

Programmable Controllers

Field I/O

Software

C-more & other HMI

Drives

Soft Starters

Motors & Gearbox

Steppers/ Servos

Motor Controls

Proximity Sensors

Photo Sensors

Limit Switches

Encoders

Current Sensors

Pressure Sensors

Temperature Sensors

Pushbuttons/ Lights

Process

Relays/ Timers

Comm.

Terminal Blocks & Wiring

Power

Circuit Protection

Enclosures

Tools

Pneumatics

Appendix

Product Index

Part # Index

Approvals

All: CENELEC EN 50041, CEI EN 60947-5-1 Plastic models: UL (508), CSA C22.2 No 14-M91

Environmental

Degree of Protection	Plastic models: IP65 according to IEC 529 Aluminum models: IP65 according to IEC 144-CEI70-1
Temperature Range	Plastic models: stocking: -30° to 80°C (-22° to 176° F) working: -25° to 70°C (-13° to 158°F) Aluminum models: stocking: -30° to 80°C (-22° to 176°F) working: -10° to 70°C (14° to 158°F); minimum temperatures assume that the atmosphere is free of moisture, which could cause moving parts to freeze up
Rated Insulation Voltage	690V (degree of pollution 3)

Mechanical Ratings

Working Positions	All actuators can be rotated in 90° increments(although some types of actuator, such as a long, heavy spring with the adjustable actuator fully extended, may not work properly if installed in a horizontal position).
Mechanical Life	Straight line working heads: 30 million operations, side rotary heads: 25 million operations, multidirectional heads: 10 million operations
Enclosure Material	Plastic models: fiberglass-reinforced plastic-V0 class (UL94); aluminum models: die cast aluminum

Contact Blocks Rating

Positive Opening*	Yes, all models	
Electrical Ratings	AC15	Make: 60A@120VAC; 30A @ 240VAC; 18A @ 400VAC Break:10A @ 24VAC; 6.5A @130VAC; 3.1A @ 230VAC; 1.8A @ 400VAC
	DC13	2.8A @ 24VDC; 0.5A @ 110VDC
Maximum Switching Frequency	Contact blocks: all two cycles per second	
Repeat Accuracy	0.01mm on the operating points at 1 million operations	
Short-Circuit Protection	Cartridge fuses gl 10A-500V 10.3x38 1 100KA	
Contact Resistance	25 milli Ω	
Recommended Minimum Operating Speed	With snap-action contacts: 20 mm per minute** With slow-action contacts: 500 mm per minute***	
Rated Insulation Voltage	660V	
Terminals Marking	According to CENELEC EN 50013	
Wiring Connections	2 x 2.5mm ² (AWG14) to 2 x 0.5mm ² (AWG18)	
Wiring Terminal Type	Captive screw with self-lifting pressure plate	
Wiring Terminal Markings	According to CENELEC EN50013	
User Protection	Double insulation (plastic models only)	

Contact Blocks Performance

Operation Frequency	3600 ops/h
Electrical Durability (according to IEC 947-5-1)	Utilization categories AC-15 and DC-13; load factor of 0.5. See table and curves below.

Tools Needed

Phillips screwdriver, #1 #2 / Hex wrench, 10mm

* Positive opening in a snap-action contact block is performed by a rigid mechanism that forces the N.C. contact to open in case the snap action mechanism fails. This would provide protection if, for example, the contacts became "welded" together by excessive current rush. Generally, positive opening is not considered to work properly on switches with actuators that are not a solid design (such as a spring or rubber roller), despite the fact that the contact block itself has positive opening. In order to be considered as having positive opening, a switch must not have flexible components between actuator actioning points and the electrical contact.
 ** This is the speed at which snap-action contact blocks are tested. There is no minimum operating speed for snap-action contacts because the speed has no influence on the switch action. When using spring actuators, the changeover time may vary from 1 to 3 ms from max. to min. operating speed.
 *** Slow-action contacts must not be operated at very low speeds because of the tendency to maintain the arc if contacts are not rapidly separated.

Electrical Durability (according to IEC 947-5-1)

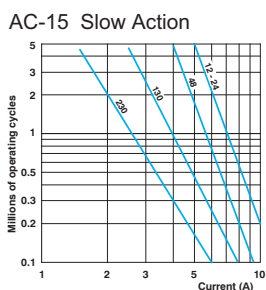
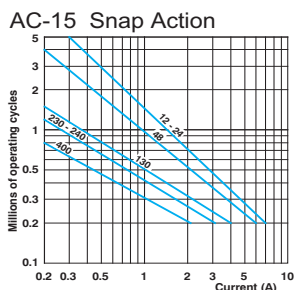

DC-13	Snap Action	Slow Action
	Power breaking for a durability of 5 million cycles	
24 Volts	9.5W	12W
48 Volts	6.8W	9W
110 Volts	3.6W	6W

IEC Limit Switches Bar Charts

Bar charts

Limit switch types

Snap action contact: A contact element in which the contact motion is independent of the speed of the actuator. This feature ensures reliable electrical performance even in applications involving very slow moving actuators.

Slow make — slow break contacts: A contact element in which the contact motion is dependent on the actuator speed.

Terminal identification (IEC)

Each terminal is marked with two digits. The first digit indicates the pole (circuit). The second digit indicates the type of contact.

1-2 is N.C., 3-4 is N.O.,
so 11-12, 21-22 are N.C., while 13-14, 23-24 are N.O.

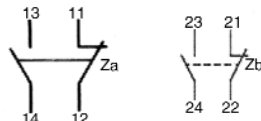

Terminal Markings	
European	
Terminal No.	Type
11-12	N.C. contact of pole no. 1 ¹
13-14	N.O. contact of pole no. 1 ¹
21-22	N.C. contact of pole no. 2 ²
23-24	N.O. contact of pole no. 2 ²

¹ With non-isolated contacts ² With isolated contacts

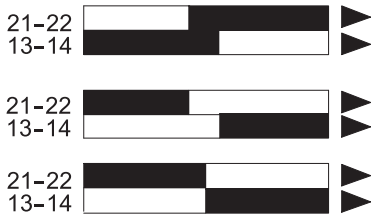

Make-before-break (overlapping) SPDT: the N.O. contact closes before the N.C. contact opens.

Break-before-make (offset) SPDT: the N.C. contact opens before the N.O. contact closes.

Simultaneous make and break SPDT: the N.C. contact opens at the same time as the N.O. contact closes.

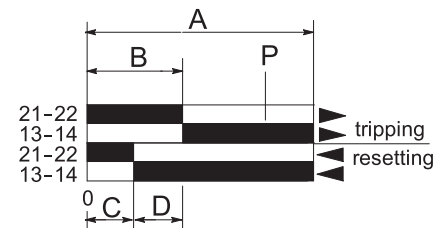

□ = Contact open

■ = Contact closed

A = Max. travel of the operator in mm or degrees

B = Tripping travel of the contact

C = Resetting travel of the contact

D = Differential travel (B - C)

P = Point from which positive opening is assured

Note: All bar charts are for standard models with snap-action contacts

Heavy-duty IEC models

Plunger and one-way lever models

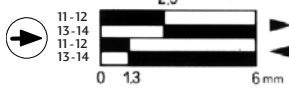

All rotary lever models

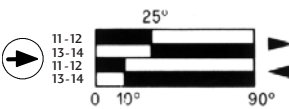

All wobble-lever models

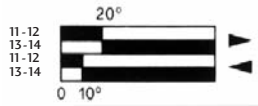

Double-insulated models

Steel plunger models

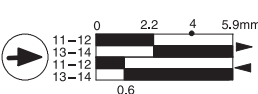

Plunger with roller models

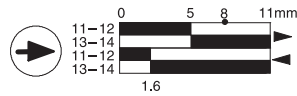

One-way lever models

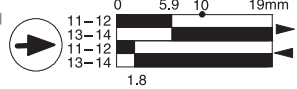

Side rotary models

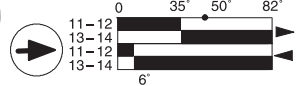

Steel rod models

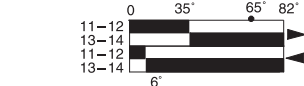

Wobble lever models

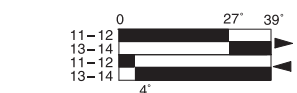

Mini DIN models

Steel plunger models

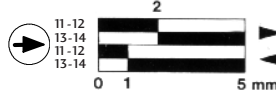

Plunger with roller models

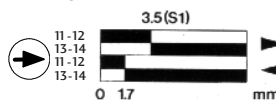

One-way lever models

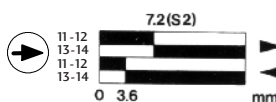

Side rotary models

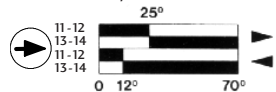

☛ = one way actuation

Changeable working heads (E42, E52, E71) models; view from the bottom

To change position, push in and twist until it locks into place

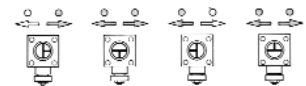

Positioning - 90° each way

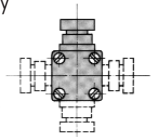

Adjustable lever from 0-360°, 6° each increment

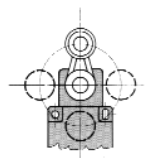

IEC Limit Switches Dimensions

Switch body dimensions

Dimensions are in millimeters. 25.4 mm = 1 inch

For example, 30 mm to inches = 30/25.4 = 1.181 inches.

Figure 1: ABM models — single-cable entry style

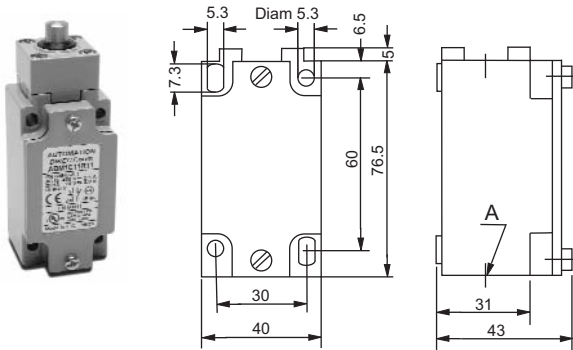

Figure 2: ABM models — 3-cable entry style

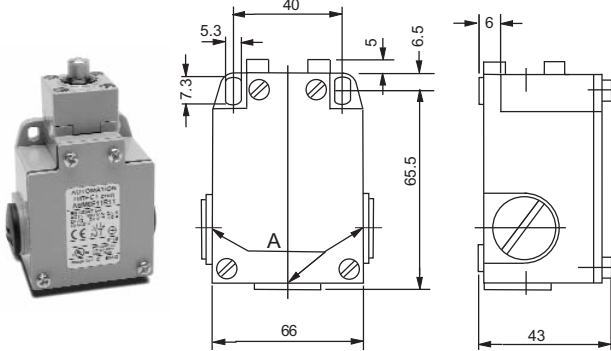

Figure 3: ABP models

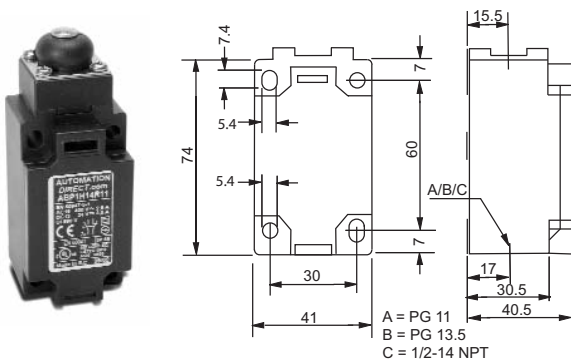
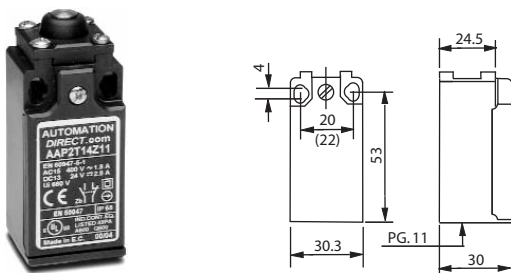

Figure 4: AAP (Mini DIN) models



Actuators - ABM, ABP models

Figure 5: Steel plunger (ABM, ABP models)

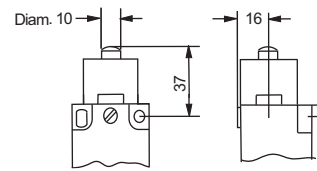

Figure 6: Plunger with roller (ABM, ABP models)

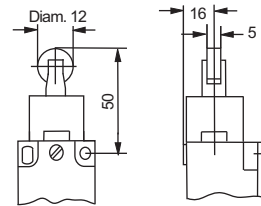

Figure 7: 1-way lever with roller (ABM, ABP models)

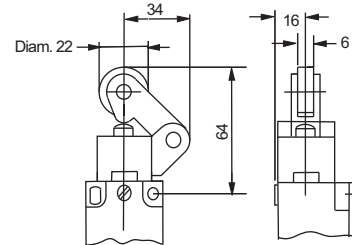

Figure 8: Side rotary with roller (ABM, ABP models)

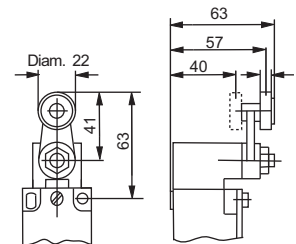
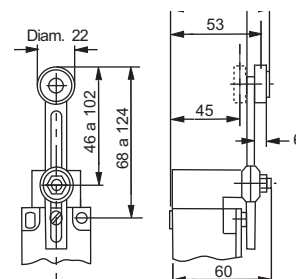

Figure 9: Side rotary with adjustable lever roller (ABM, ABP models)



IEC Limit Switches Dimensions

Figure 10: Side rotary with rod (ABM, ABP models)

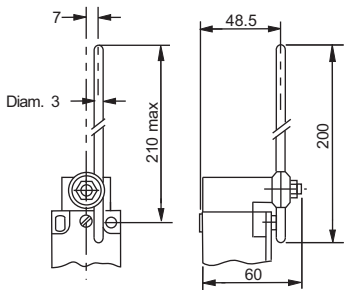

Figure 11: Wobble-type with spring with tip (ABM, ABP models)

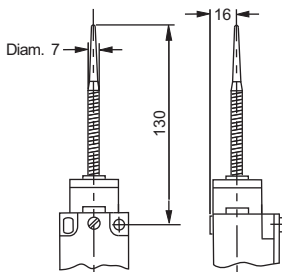

Figure 12: Wobble-type steel spring (ABM, ABP models)

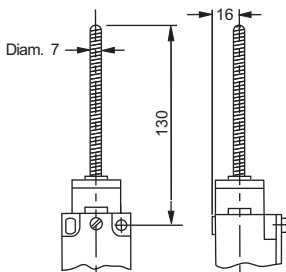

Figure 13: Optional lever arm (ABM models) AGE44-LEVER

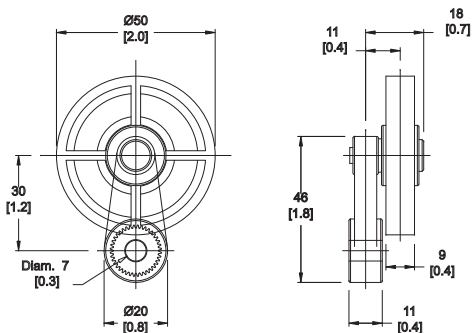
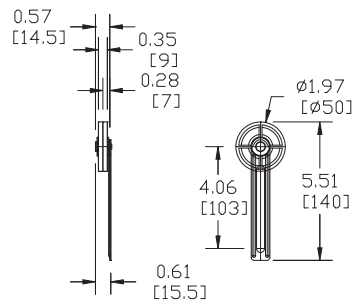

Figure 14: Optional lever arm (ABM models) AGE54-LEVER



Actuators — mini-DIN (AAP) models

Figure 15: Steel plunger (AAP models)

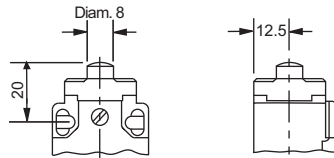

Figure 16: Steel plunger with roller (AAP models)

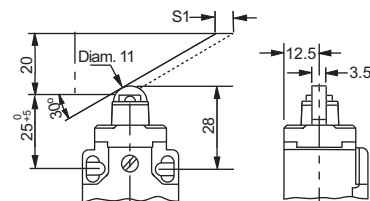

Figure 17: One-way lever with roller (AAP models)

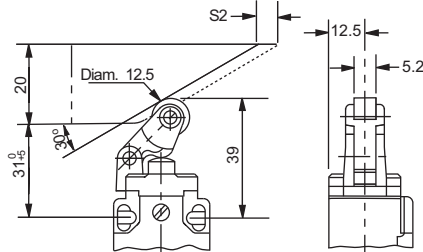

Figure 18: Side rotary lever with roller (AAP models)

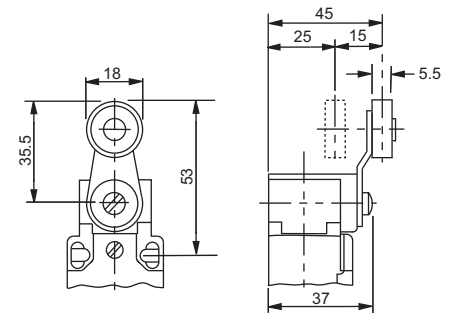

Figure 19: Side rotary lever with adj. lever roller (AAP models)

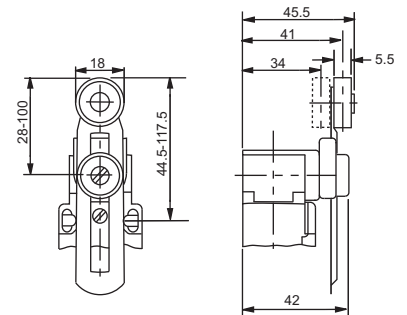
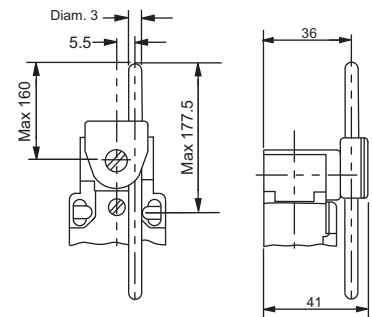

Figure 20: Side rotary lever with rod actuator (AAP models)



Dimensions are in millimeters (25.4 mm = 1 inch). For example, 30 mm to inches = 30/25.4 = 1.181 inches.