

RHINO PSM Series Power Supplies

Versatile switching power supplies are DIN-rail mountable

AUTOMATIONDIRECT offers the most practical industrial control power supplies available. The RHINO PSM series power supplies are industrial grade switching DC output supplies with a sturdy steel case to withstand harsh environments. Autoselect inputs for 115 VAC or 230 VAC and international agency approvals make the RHINO PSM series suitable for worldwide use. RHINO PSM power supplies are available in 12 or 24 VDC output, with adjustable output voltages, and feature low output ripple along with overload and overtemperature protection. The seven models offer power ratings from 78W to 600W, and up to 25A output current.

Features

- Industrial grade design
- Sturdy metal case to withstand harsh industrial environments
- Model PSM24-090S-N meets NEC Class 2
- Universal 100/230 VAC input voltage
- Adjustable output voltage
- Low output ripple
- Short-circuit, overvoltage and overtemperature protection
- Power Good signal
- Remote ON/OFF
- Optional wall mounting
- Specialty modules for redundancy, power backup and UPS
- Terminal connectors included
- 3-year product warranty

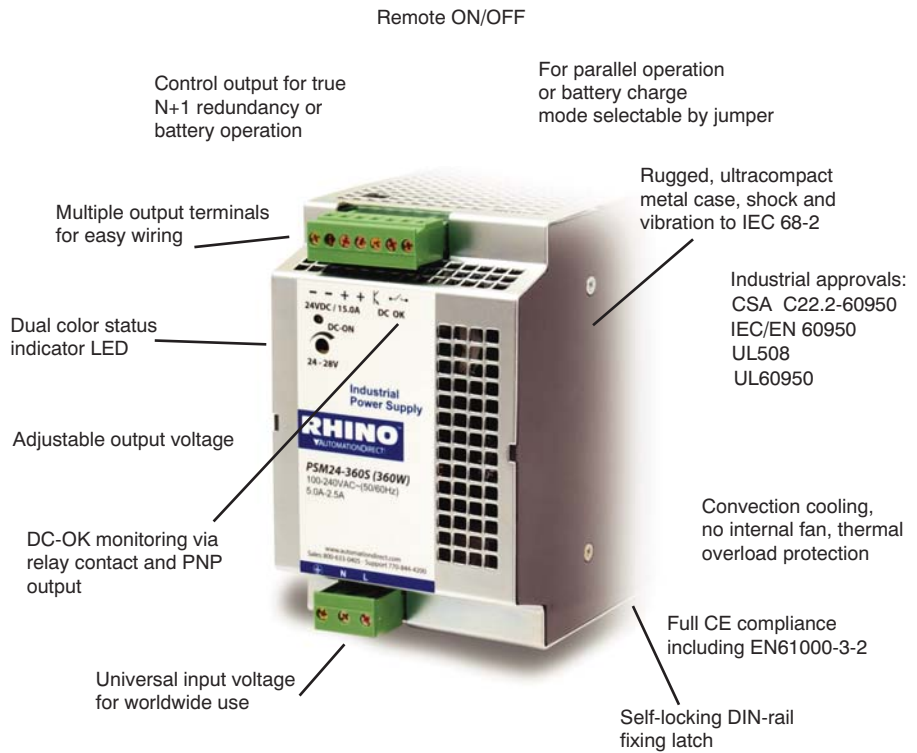

Part Numbering System

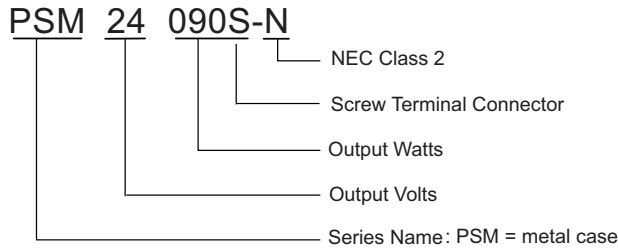

RHINO PSM Industrial Power Supplies			
Part Number	*Output Voltage (V_{nom})	**Output Current (I_{max})	***Output Power (P_{max})
PSM12-078S	12 VDC	6.5 A	78 W
PSM24-090S	24 VDC	3.75 A	90 W
PSM24-090S-N	24 VDC	3.75 A	90 W
PSM12-156S	12 VDC	13.0 A	156 W
PSM24-180S	24 VDC	7.5 A	180 W
PSM24-360S	24 VDC	15.0 A	360 W
PSM24-600S	24 VDC	25.0 A	600 W

*12V models adjustable from 12 to 14 VDC. 24V models adjustable from 24 - 28 VDC

**Maximum current at nominal output voltage

***Up to an operating temperature of +40°C



Company Information

Systems Overview

Programmable Controllers

Field I/O

Software

C-more & other HMI

Drives

Soft Starters

Motors & Gearbox

Steppers/ Servos

Motor Controls

Proximity Sensors

Photo Sensors

Limit Switches

Encoders

Current Sensors

Pressure Sensors

Temperature Sensors

Pushbuttons/ Lights

Process

Relays/ Timers

Comm.

Terminal Blocks & Wiring

Power

Circuit Protection

Enclosures

Tools

Pneumatics

Appendix

Product Index

Part # Index

RHINO PSM Series Power Supplies Specifications

Input Specifications									
Part Number	Input Voltage Range	Input Frequency Range	Input Current (Typical) at full load		Inrush Current max (<2ms) @ +25°C		Holdup Time	Efficiency (Typical) @ 115VAC	Circuit Breaker or Fuse (slo-blo)
			115 VAC	230 VAC	115 VAC	230 VAC			
PSM12-078S	100 - 240 VAC 85 - 264 VAC (47 - 63 Hz)	47-63 Hz	2.0 A	1.0 A	<12 A	<20 A	20 ms min. (full load 115/230 VAC)	82%	6.0 A to 16.0 A
PSM24-090S			2.1 A	1.0 A				85%	
PSM24-090S-N			2.1 A	1.0 A				85%	
PSM12-156S	100 - 120 VAC/ 220 - 230 VAC		2.5 A	1.4 A	<13 A	<25 A		85%	
PSM24-180S	85 - 132 VAC/ 187 - 264 VAC		2.8 A	1.5 A				88%	
PSM24-360S	85 - 132 VAC/ 187 - 264 VAC (47 - 63 Hz) Autoselect		5.0 A	2.5 A	<16 A	<25 A		87%	
PSM24-600S			10.0 A	5.0 A				<25 A	<30 A

Output Specifications										
Part Number	Price	Output Voltage	Output Voltage Adj. Range	Output Current (Max.)	Output Power (Max.)	Output Overvoltage Protection	Power - Good Signal			MTBF (IEC 61709 @ 25°C)
							Trigger Threshold	Active Output Signal	Relay Output	
PSM12-078S	<--->	12 VDC	12 - 14 VDC	6.5 A	78 watts	20 V	9 - 11 V	11 V ± 1 V/20 mA max.	DC OK = contact closed (rated:30 VDC 1.0A)	350,000 hours
PSM24-090S	<--->	24 VDC	24 - 28 VDC	3.75 A	90 watts	35 V	18 - 22 V	22 V ± 2 V/10 mA max		
PSM24-090S-N	<--->			3.75 A	90 watts	35 V		22 V ± 2 V/10 mA max		
PSM12-156S	<--->	12 VDC	12 - 14 VDC	13.0 A	156 watts	20 V	9 - 11 V	11 V ± 1 V/40 mA max.		
PSM24-180S	<--->	24 VDC	24 - 28 VDC	7.5 A	180 watts	35 V	18 - 22 V	22 V ± 2 V/20 mA max		
PSM24-360S	<--->			15.0 A	360 watts	35 V				
PSM24-600S	<--->			25.0 A	600 watts	35 V				

General Specifications	
Specification	Description
Temperature	Operating (ambient): -25°C to + 70°C max (-13°F to 158°F). Above +40°C(104°F) load derating Storage (non-operating): -25°C to + 85°C max (-13°F to 185°F). Temperature drift: 0.02%/C. Cooling: convection, no internal fan
Humidity	95% (non-condensing) relative humidity maximum
Isolation	According to IEC/EN 60950, EN50178, EN61558-2-8, EN60204, CSA
Output Regulation	Input variation: 0.5% maximum. Load variation (10 to 100%): 0.5% maximum
Output Voltage Ripple	100 mV peak-to-peak typical (20 MHz bandwidth), (200 mV peak - peak maximum at Imax)
Output Protection	Current limit: 110% constant current, automatic recovery, thermal protection, output rating, Voltage limit: 140% Vout nom
Over-temperature Protection	Switch off at over-temperature, automatic restart
Status Indicator	Dual color LED (green: DC Ok; Red: DC Off)
Remote ON/OFF	By external contact. DC On: -S contact open. DC Off: -S connected via 1 KΩ to -Vout, [3VDC max across Vout(+) and Vout(-)]
Maximum Capacitive Load	Unlimited
Vibration	IEC 60068-2-6: 3 axis, sine sweep, 10-55 Hz, 1g, 1 oct/min
Shock	IEC 60068-2-27: 3 axis, 15g half sine, 11ms
Enclosure Rating	IP20 (IEC 529)
Enclosure Material	Aluminum (chassis) / zinc plated steel (cover)
Mounting	Snap-on with self-locking spring for 35mm DIN rails per EN 50022-35x15/75, or wall mount with bracket
Connection	Pluggable screw terminals (plugs included) 2 terminals per output (not available in 600 watt unit.)
Agency Approvals	UL 508 Listed File E197592, UL 60950 Recognized File E198298; CSA C22.2-60950 File 229285; CE

Note: Unless otherwise stated all specifications are valid at nominal input voltage, full load and +25°C after warmup time.

RHINO PSM Series Power Supplies Specifications

General Specifications (continued)		
Specification	Standard	Document Number
Harmonic Limits	Harmonic Current Limits	EN 61000-3-2, Class A for limited output power
Safety Standards	Information technology equipment	IEC/EN60950; CSA 60950-1-03/UL 60950-1
	Industrial control equipment	UL 508
	Electrical equipment of machines	EN 60204
	Electronic equipment for power installation	EN 50178
	Safety, transformers	EN 61558-2-8
	Limited power source (model PSM24-090S-N)	EN 60950 sect. 2.5 and NEC Class 2
Safety Approvals	CB-Report per IEC 60950	EN 50178, EN 60079-15 EN 61558-2-8, CSA
Safety Class	Degree of electrical protection Class1	IEC 536
Electromagnetic Compatibility (EMC), Emissions	EMC, Emissions	EN 61204-3, EN61000-6-3
	Conducted RI suppression on input	EN 55011 class B, EN 55022 class B
	Radiated RI suppression	EN 55011 class B, EN 55022 class B
Electromagnetic Compatibility (EMC), Immunity	EMC, Immunity	EN 61000-6-2, EN 61204-3
	Electrostatic Discharge (ESD)	IEC / EN 61000-4-2 4 kV (contact discharge) / 8 kV (air discharge)
	Radiated RF field immunity (80-1000 MHz)	IEC / EN 61000-4-3 10 V / m
	Electrical fast transient / burst immunity	IEC / EN 61000-4-4 2 kV
	Surge immunity	IEC / EN 61000-4-5 1 kV / 2 kV
	Immunity to conducted RF disturbances (0.15 to 80 MHz)	IEC / EN 61000-4-6 10 V
	Power frequency field immunity	IEC / EN 61000-4-8 30 A / m
	Voltage dips	IEC / EN 61000-4-11(70% UN Crit. B/40%/100% UN Crit. C)
Pollution Degree	2*	

*Note: Normally, only non-conductive pollution occurs. Temporary conductivity caused by condensation is to be expected.

Output Power Derating

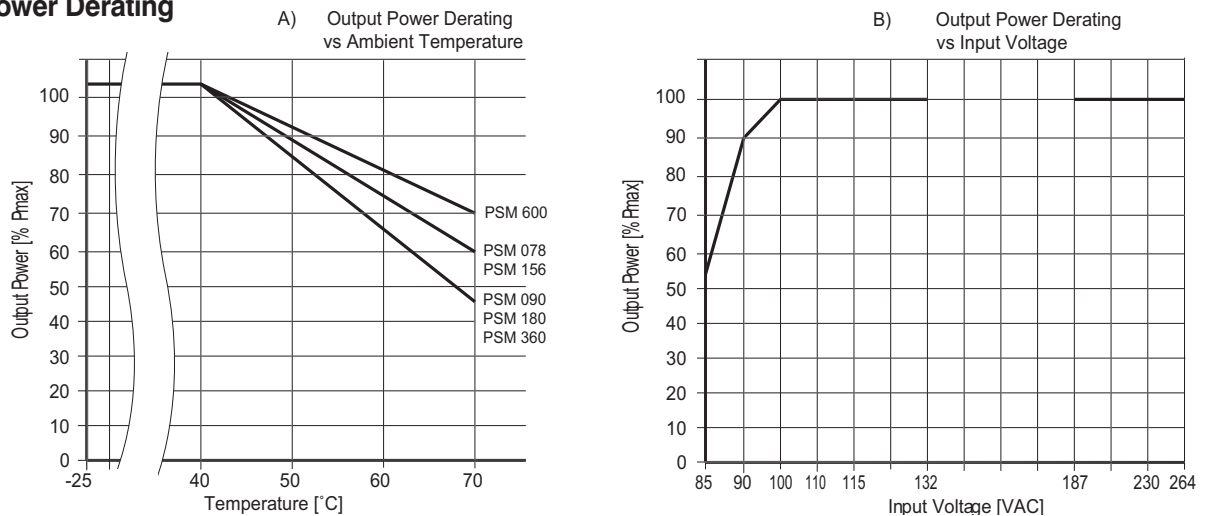

Note: Unless otherwise stated, all specifications are valid at nominal input voltage, full load and +25°C after warmup time.



RHINO PSM Series Dimensions/Connections

PSM12-078S/PSM24-090S
PSM24-REM360S
PSM24-BCM360S

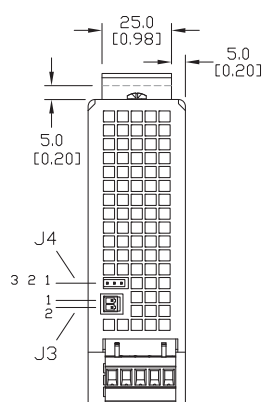

	J1	J2	J3	J4
Pin 1	Earth	GND (-)	S+	Normal mode
Pin 2	Neutral	Vout (+)	S-	Common
Pin 3	Line	DC-OK Signal	—	Parallel mode
Pin 4	—	DC-OK Relay contact 1	—	—
Pin 5	—	DC-OK Relay contact 2	—	—

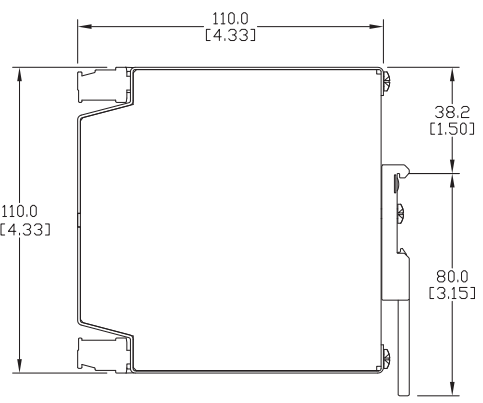
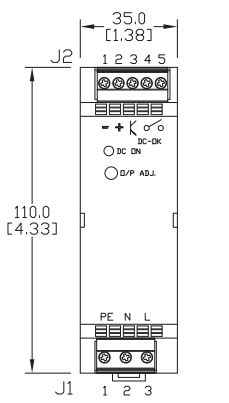

PSM12-156S/PSM24-180S
PSM24-BFM600S

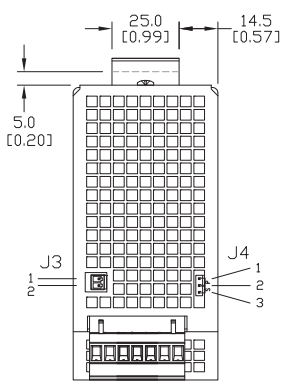

	J1	J2	J3	J4
Pin 1	Earth	GND (-)	S+	Normal mode
Pin 2	Neutral	GND (-)	S-	Common
Pin 3	Line	Vout (+)	—	Parallel mode
Pin 4	—	Vout (+)	—	—
Pin 5	—	DC-OK Signal	—	—
Pin 6	—	DC-OK Relay contact 1	—	—
Pin 7	—	DC-OK Relay contact 2	—	—

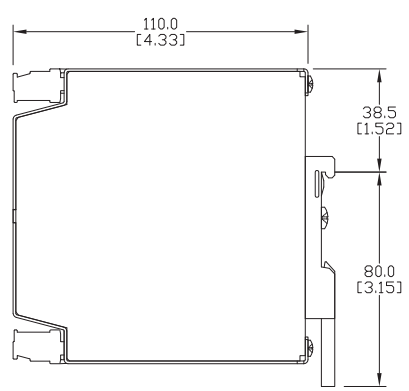
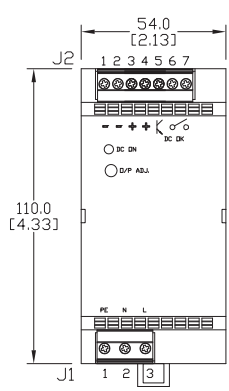

RHINO PSM Series Dimensions/Connections

PSM24-360S

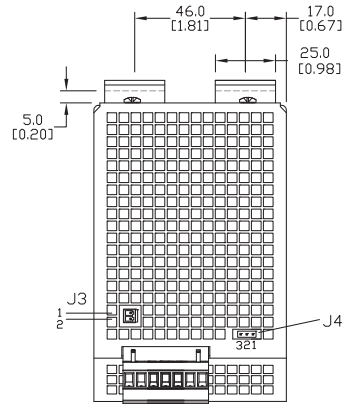

	J1	J2	J3	J4
Pin 1	Earth	GND (-)	S+	Normal mode
Pin 2	Neutral	GND (-)	S-	Common
Pin 3	Line	Vout (+)	—	Parallel mode
Pin 4	—	Vout (+)	—	—
Pin 5	—	DC-OK Signal	—	—
Pin 6	—	DC-OK Relay contact 1	—	—
Pin 7	—	DC-OK Relay contact 2	—	—

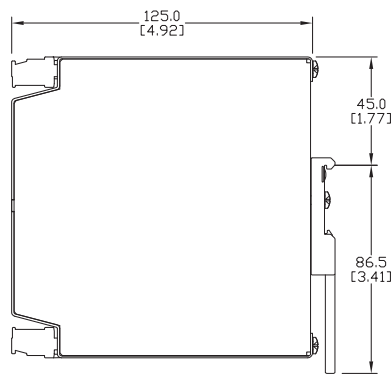
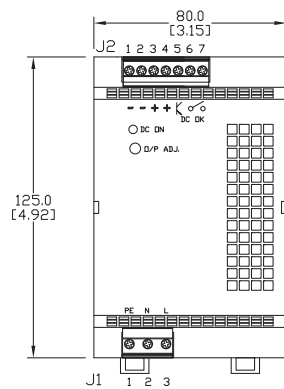

PSM24-600S

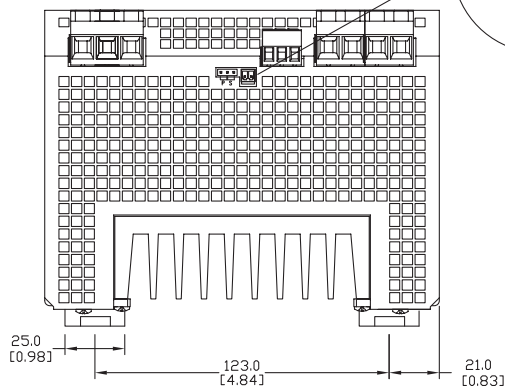
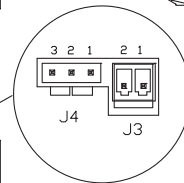
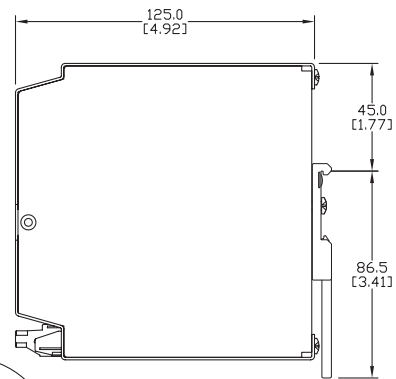
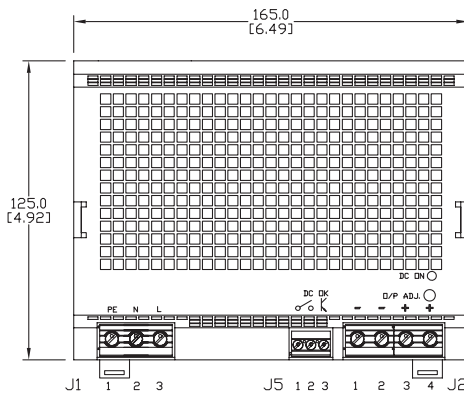

	J1	J2	J3	J4	J5
Pin 1	Earth	GND (-)	S+	Normal mode	DC-OK Relay contact 1
Pin 2	Neutral	GND (-)	S-	Common	DC-OK Relay contact 2
Pin 3	Line	Vout (+)	—	Parallel mode	DC-OK Signal
Pin 4	—	Vout (+)	—	—	—

RHINO PSM Power Supplies - Accessories

A variety of accessories is available to complement the RHINO PSM power supplies. Choose panel mounting brackets and replacement plug kits from the table below, based on the size of the power supply. There is also a temperature sensor for the battery control module and replacement link cable for the redundancy and battery control modules.



Accessories		
Part Number	Price	Description
PSM-PANEL1	<--->	Panel mounting bracket. 1 bracket type A includes M4-screw (DIN 74-4fA) for 78W, 90W, 156W, 180W PSM power supplies
PSM-PANEL2	<--->	Panel mounting bracket. 2 brackets type A include M4-screws (DIN 74-4fA) for 360W, 600W PSM power supplies
PSM-PK1	<--->	Replacement plug kit for PSM series with 78W and 90W outputs
PSM-PK2	<--->	Replacement plug kit for PSM series with 156W, 180W and 360W outputs
PSM-PK3	<--->	Replacement plug kit for PSM series redundancy module
PSM-PK4	<--->	Replacement plug kit for PSM series buffer module
PSM-PK5	<--->	Replacement plug kit for PSM series battery control module
PSM-TS	<--->	Temperature sensor for PSM24-BCM360S battery control module
PSM-JC01	<--->	Replacement link cable for PSM series redundancy module PSM24-REM360S and battery control module PSM24-BCM360S

Mounting

PSM power supplies are designed for mounting on a DIN rail. Please allow minimum free space of 80 mm (3.15") above and below, and 50 mm (1.97") on each side of the power supply for air convection. To attach unit onto the DIN rail, hook the top part of clip on DIN rail, then push down and inward until you hear the clipping sound. To remove, pull the latch of the clip using an insulated flat-head screwdriver.

For wall or chassis mounting, use mounting brackets PSM-PANEL1 (for 78W to 180W PSM style power supplies) or PSM-PANEL2 (for 360W and 600W PSM power supplies). Remove the DIN clips and replace with the brackets. Use the countersink screws included with the wall mount kit to attach the brackets to the power supply.

To attach the power supply to the DIN rail

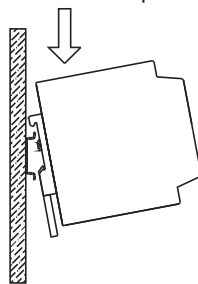

Fig. 2.1

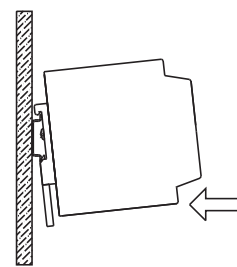

Fig. 2.2

To remove the power supply from DIN rail

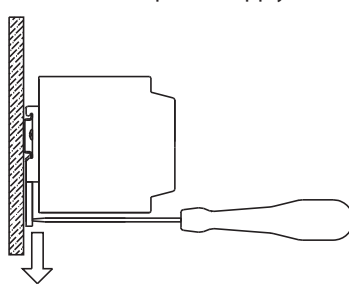

Fig. 2.3

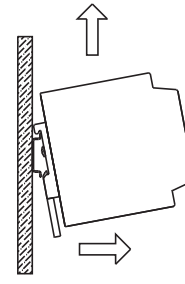
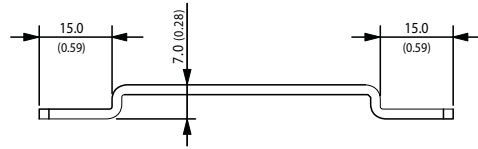
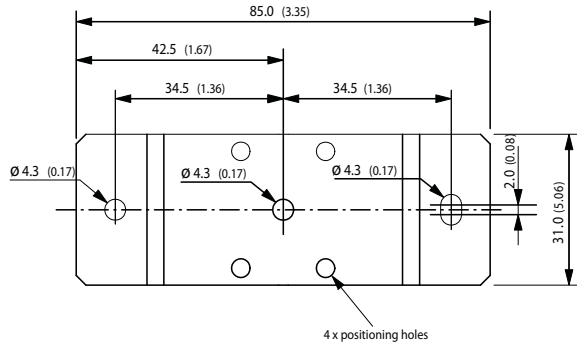

Fig. 2.4

RHINO PSM Panel Mounting Bracket Dimensions

PSM-PANEL1



Material: 2 mm Mild Steel
Tolerance: $\pm 0.1\text{mm}$ (± 0.004)

PSM12-078S, PSM24-090S

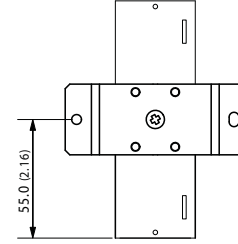

PSM12-156S, PSM24-180S

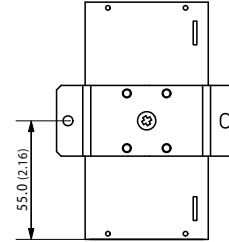

PSM-PANEL2

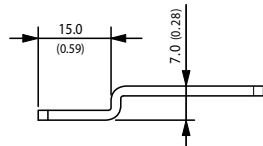
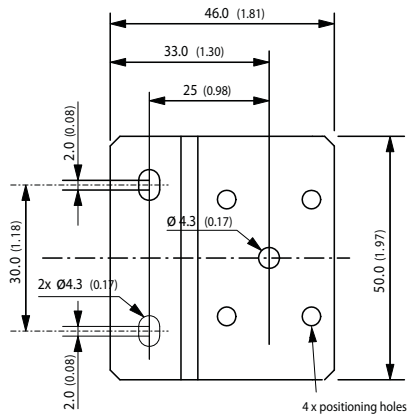

Material: 2 mm Mild Steel
Tolerance: $\pm 0.1\text{mm}$ (± 0.004)

Dimensions: [mm] () = Inch

PSM24-360S

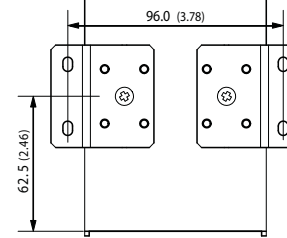

PSM24-600S

