

Bases

Please note: \$US prices shown
For current \$AUD visit www.directautomation.com.au

P2-04B \$107.00

P2-07B \$144.00

P2-11B \$188.00

P2-15B \$220.00

The P2-04B, P2-07B, P2-11B, and P2-15B are 4, 7, 11, or 15-slot I/O bases respectively.

See Dimensions and Installation for base dimensions.

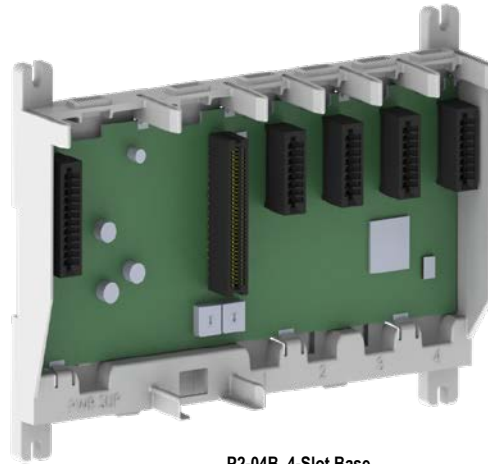

P2-04B 4-Slot Base

Base Specifications	
Input or Output Modules per Base	4, 7, 11, or 15
Power Supply Slots	1 (For P2-01AC, P2-01DCAC, P2-01DC, or P2-02DC)
CPU Slots	1 (P2-550)
Module Types Supported	Discrete, analog and specialty
Module Placement Restrictions	None. Any I/O module may be installed in any I/O slot without power supply budget or module type restrictions.
I/O Module Hot Swap Support	Yes. All discrete, analog and specialty modules can be software enabled for Hot Swap operation.
Module Keying	Electronic to slot
Maximum Number of Local Bases	1

Base Configuration

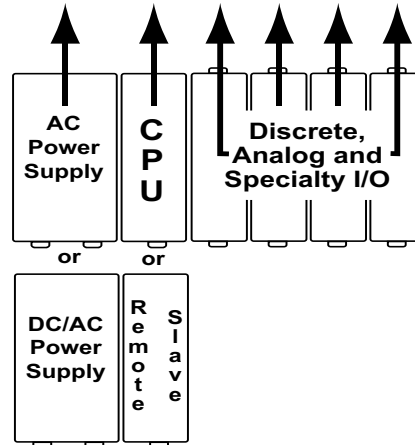
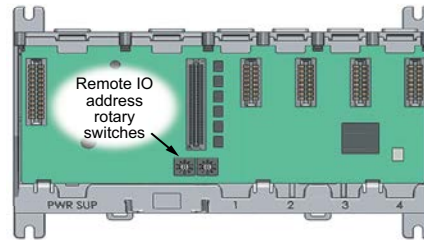

General Specifications	
Operating Temperature	0° to 60°C (32° to 140°F)
Storage Temperature	-20° to 70°C (-4° to 158°F)
Humidity	5 to 95% (non-condensing)
Altitude	2000 meters max.
Pollution Degree	2
Environmental Air	No corrosive gases permitted
Vibration	IEC60068-2-6 (Test Fc)
Shock	IEC60068-2-27 (Test Ea)
Overvoltage Category	II
Heat Dissipation	3W
Weight	P2-04B: 204g (7.2 oz) P2-07B: 294g (10.4 oz) P2-11B: 430g (15.2 oz) P2-15B: 539g (19oz)
Agency Approvals**	UL 61010-1 and UL 61010-2-201 File E139594, Canada and USA CE (EN 61131-2 EMC, EN 61010-1 and EN 61010-2-201 Safety)*

*Meets EMC and Safety requirements. See the Declaration of Conformity for details.
**To obtain the most current agency approval information, see the Agency Approval Checklist section on the specific component part number web page.

Dimensions and Installation

It is important to review and understand the installation requirements for your Productivity® 2000 system. Your knowledge of these requirements will help ensure that your system operates within safe environmental and electrical limits.

Plan for Safety

This catalog should never be used as a replacement for the product inserts and user manual. Each base, CPU, power supply, I/O module, and specialty module comes with a product insert. You can purchase, download for free, or view online the Productivity2000 user manual (P2-USER-M). These documents, along with the software help files, contain important safety information that must be followed.

The system installation should comply with all appropriate electrical codes and standards.

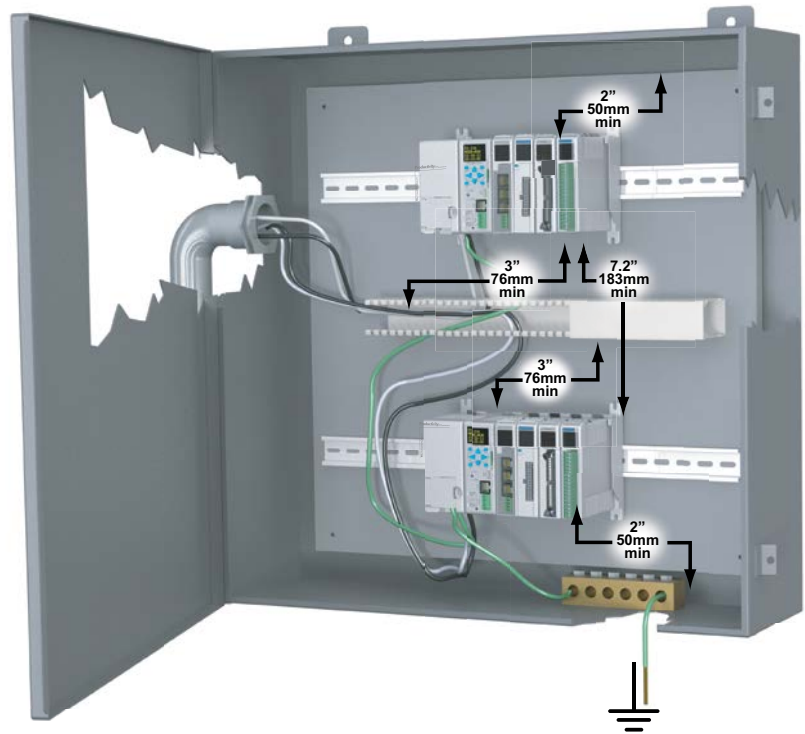

Enclosures

Your selection of a proper enclosure is important to ensure safe and proper operation of your Productivity2000 system. Applications for the Productivity2000 system vary and may require additional hardware considerations. The minimum considerations for enclosures include:

- Conformance to electrical standards
- Protection from the elements in an industrial environment
- Common ground reference
- Maintenance of specified ambient temperature
- Access to the equipment
- Security or restricted access
- Sufficient space for proper installation and maintenance of the equipment

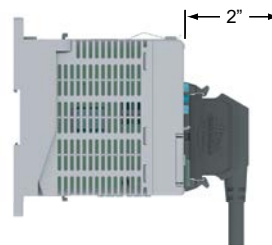
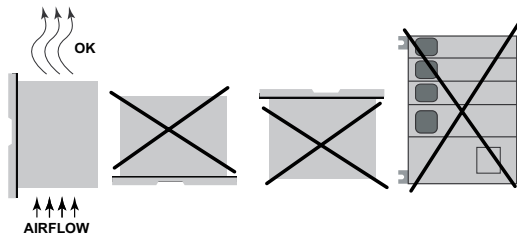

NOTE: Add 2" to mounting depth when using ZIPLink cable.

Mounting Position

Mount the bases horizontally, as shown in the illustration, to provide proper ventilation. Do not mount the bases vertically, upside down, or on a flat horizontal surface.

Dimensions and Installation

Mounting Clearances

Provide a minimum clearance of 2 inches (50mm) between the bases and all sides of the enclosure. Allow extra door clearance for operator panels and other door mounted items. There should be a minimum of 3 inches (76mm) clearance between the base and any wire duct, and a minimum of 7.2 inches (183mm) from base to base in a multiple base installation.

Grounding

A good common ground reference (earth ground) is essential for proper operation of the Productivity®2000 system. One side of all control circuits, power circuits and the ground lead must be properly connected to earth ground by either installing a ground rod in close proximity to the enclosure or by connecting to the incoming power system ground. There must be a single-point ground (i.e. copper bus bar) for all devices in the enclosure that require an earth ground.

Temperature Considerations

The Productivity2000 system should be installed in an environment operating within the equipment operating temperature specifications. If the temperature deviates above or below the specification, measures such as cooling or heating the enclosure should be taken to maintain the specification.

Power Considerations

The Productivity2000 system is designed to be powered by any of the Productivity2000 power supplies. The Productivity2000 has achieved CE certification without requiring EMF/RFI line noise filters on the power supplies. Please review the "EU Directives" document, located in the User Manual or at www.productivity2000.com, for applications which require CE Compliance.

Base Dimensions, inches[mm]

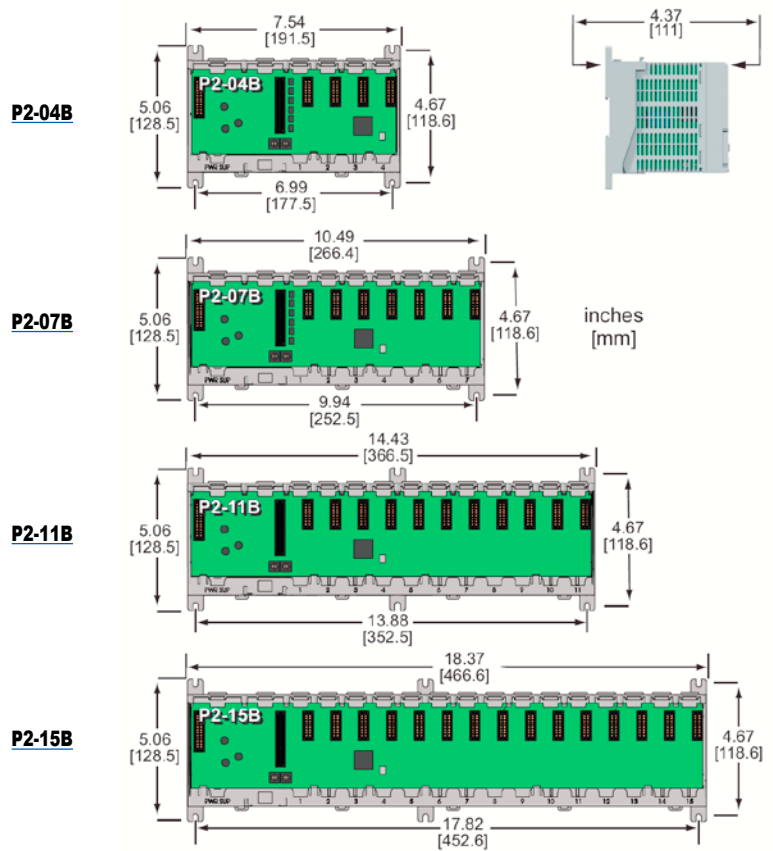

Base Installation

Using Mounting Rails

The Productivity®2000 bases can be secured to the cabinet using mounting rails. Use rails that conform to DIN EN standard 50022. ADC offers a complete line of DIN rail, DINnectors and DIN rail mounted apparatus. The rails are approximately 35mm high, with a depth of 7.5 mm. When mounting the base on a rail, consider using end brackets on each side of the base. The end brackets keep the base from sliding horizontally along the rail. This minimizes the possibility of accidentally pulling the wiring loose.

Several retaining clips are located on the lower rear surface of the base of the base. To secure the base to a DIN rail, place the base onto the rail and gently push up on the retaining clips. The clips lock the base onto the rail.

To remove the base, pull down on the retaining clips, lightly pull forward from the bottom and rotate the base, pulling it away from the rail.

